

PQube[®] 3

Instruction Manual

Revision 1.9



WARNING: Death, serious injury, or fire hazard could result from improper connection or operation of this instrument. Carefully read and understand manual before connecting this instrument.

AVERTISSEMENT: Si l'instrument est mal connecté, la mort, des blessures graves, ou un danger d'incendie peuvent s'en suivre. Lisez attentivement le manuel avant de connecter l'instrument.

WARNUNG: Der falsche Anschluß dieses Gerätes kann Tod, schwere Verletzungen oder Feuer verursachen. Bevor Sie dieses Instrument anschließen, müssen Sie die Anleitung lesen und verstanden haben.

ADVERTENCIA: Una conexión incorrecta de este instrumento puede producir la muerte, lesiones graves y riesgo de incendio. Lea y entienda el manual antes de conectar.

If this equipment is used in a manner not specified by the manufacturer, the protection provided by the equipment may be impaired. Installation, service, and maintenance of your PQube must only be done by qualified personnel for electrical installations.







© 2008-2015 Power Sensors Ltd. All rights reserved. No parts of this document may be copied, reproduced, or translated to another language without the prior written consent of Power Sensors Ltd. "PQube 3" is a registered trademark of Power Sensors Ltd. "Windows" "Excel", and "PowerPoint" are registered trademarks of Microsoft Corporation.

The information contained in this document is subject to change without notice.

PSL MAKES NO WARRANTY OF ANY KIND WITH REGARD TO THIS MATERIAL, INCLUDING, BUT NOT LIMITED TO, THE IMPLIED WARRANTIES OF MERCHANTABILITY AND FITNESS FOR A PARTICULAR USE.

PSL shall not be liable for errors contained herein or for incidental or consequential damages in connection with the furnishing, performance, or use of this material. If you do not accept this limitation on liability, please return the product to PSL prior to use.

Produced in the United States of America.

Symbol	Meaning
	Caution. Consult this manual in all cases where this symbol is marked, in order to find out the nature of the potential hazards and any actions which have to be taken to avoid them.
	Caution. Risk of electric shock
	Alternating current
	Alternating current (a.c.) or direct current (d.c.)
	Double or Reinforced insulation
	Functional earth terminal <u>not</u> relied on for safety

Document Release Date: September 2015

1 Table of Contents

1	Table of Contents	3
2	Introduction	7
2.1	What is a PQube® 3?.....	7
2.1.1	What does my PQube 3 record?	7
2.1.2	What kind of software do I need?	7
2.1.3	Which configurations are supported?	8
2.1.4	How do I power my PQube 3?	8
2.1.5	How do I communicate with my PQube 3?	8
2.2	How Is Your PQube 3 Different?	9
2.3	Overview of PQube 3 Ports, Connections, and Controls	10
2.4	Choosing Modules	11
2.4.1	Power your PQube 3 from 100~240Vac	12
2.4.2	Backup your PQube 3 during a power outage.....	12
2.4.3	Measure the 1A or 5A secondary wires of external current transformers.....	13
2.4.4	Measure Environmental Conditions	13
2.4.5	Synchronize your PQube 3 to GPS time	14
3	Installing Your PQube 3	15
3.1	Installation Guide.....	15
3.1.1	Disconnect mains prior to servicing	15
3.1.2	Mount your PQube 3 properly and securely	15
3.1.3	Include overcurrent protection and a disconnecting device.....	16
3.1.4	Protect the operator from the hazardous terminals.....	16
3.1.5	Connect your PQube 3 to the power supply	18
3.1.6	Connecting the wires.....	20
3.1.7	Connect mains AC voltage wires.....	22
3.1.8	Protect antenna terminals from lightning	23
3.1.9	Installing Your PM1 Power Supply Module	23
3.1.10	Installing Your UPS Module.....	23
3.1.11	Installing Current Transformers (CTs)	24
3.1.12	Connecting the ENV2 environmental probes	27
3.1.13	Installing Your MS1 Sync Module (GPS option).....	27

- 3.2 Wiring Diagrams 29**
 - 3.2.1 Single Phase L1-N..... 29
 - 3.2.2 Single Phase L1-L2..... 29
 - 3.2.3 Single Split Phase 30
 - 3.2.4 Delta – 3 CTs 30
 - 3.2.5 Delta – 2 CTs (PQube 3 calculates current on remaining channel) 31
 - 3.2.6 Wye/Star..... 31
 - 3.2.7 Measuring Neutral Current (applies to any power configuration with Neutral) 32
 - 3.2.8 Measuring Earth Current (applies to any power configuration)..... 32
 - 3.2.9 Measuring Net Earth Current – Delta 33
 - 3.2.10 Measuring Net Earth Current – Wye/Star 33
- 3.3 Low Voltage Input/Output Terminals 34**
- 4 Setting Up Your PQube 3 35**
 - 4.1 Your Setup File 35
 - 4.2 Initial Device Setup 36
 - 4.2.1 Set the Date and Time 36
 - 4.2.2 Set Your Languages 36
 - 4.2.3 Set Your Potential Transformer (PT) Ratio 37
 - 4.2.4 Set Your Current Transformer (CT) Ratio 38
 - 4.2.5 Verify your PQube 3 has been configured correctly..... 39
 - 4.2.6 Common Installation Errors 39
- 5 PQube 3 Operation 41**
 - 5.1 User Controls 41
 - 5.1.1 Navigating the Touchscreen Display..... 41
 - 5.1.2 Rebooting Your PQube 3..... 49
 - 5.1.3 Ejecting your USB thumb drive or microSD card 50
 - 5.2 Accessing the FTP Server on Your PQube 3 51
 - 5.3 Accessing the HTTP Web Server on Your PQube 3..... 52
 - 5.3.1 Status 53
 - 5.3.2 Meters..... 54
 - 5.3.3 Events..... 55
 - 5.3.4 Trends 56
 - 5.3.5 Commands..... 57
 - 5.4 PQube 3 Email Setup 58

5.4.1	Setting up an email account for your PQube 3.....	58
5.4.2	Getting event notifications and trend data from your PQube 3 by email.....	59
5.4.3	Sending commands to your PQube 3 over email.....	60
5.5	Modbus Setup.....	62
5.5.1	Basics.....	62
5.5.2	Scan rates, client load, and limitations.....	62
5.5.3	Supported Clients.....	62
5.5.4	Register List (refer to Modbus Reference Manual).....	62
5.5.5	Downloads.....	62
5.6	LED Definitions.....	63
5.6.1	PQube 3.....	63
5.6.2	MS1.....	64
5.6.3	PM1/PM2.....	64
5.6.4	UPS1.....	65
5.6.5	ENV1/ENV2.....	65
5.7	Upgrading the Firmware on your PQube 3.....	66
5.8	Maintenance.....	68
5.8.1	Turning Off Your PQube 3.....	68
5.8.2	Replacing Your PQube 3's Clock Battery.....	68
5.8.3	Life Expectancy of the PQube 3 and the PM1 module.....	68
5.8.4	UPS1 Life Expectancy and Long Term Storage Instructions.....	68
5.8.5	Cleaning Instructions.....	69
5.8.6	Reasons for reset.....	69
5.9	Calibration Information for Your PQube 3.....	69
5.10	PQube 3 technical specifications.....	69
6	<u>Appendix 1: Setup File Guide</u>.....	70
6.1.1	Device Setup.....	70
6.1.2	Event Triggering.....	79
6.1.3	Network Configuration.....	89
6.1.4	Protocols and Synchronization.....	94
6.1.5	System and Services.....	96
6.1.6	Trend Setup.....	97
7	<u>Appendix 2: Major Dip Curves</u>.....	100
7.1.1	STANDARD.....	100

7.1.2	SEMI F47	101
7.1.3	Samsung Power Vaccine	101
7.1.4	ITIC	102
7.1.5	CBEMA	102
7.1.6	MIL-STD 704E.....	103
7.1.7	MIL-STD 1399.....	103

2 Introduction

2.1 What is a PQube® 3?

Your PQube® 3 is an instrument for monitoring electric power systems and environmental conditions, designed to help you solve problems that impact the quality and reliability of your product or process.

Think of it as a black box for your electric power and environment. It is a combination of a power disturbance monitor, a power/energy meter, a data logger, and a digital fault recorder – it combines the best features of all four. It's easy to use, too. Just transfer the data to your computer using a standard flash device like a USB drive or SD card, like you would with a digital camera. No special training is needed to operate your PQube 3.

2.1.1 What does my PQube 3 record?

Your PQube 3 records disturbances on the mains circuit: sags/dips, swells, interruptions, frequency variations, impulses, and waveform snapshots. It also records power quality parameters like flicker, unbalance, THD and harmonics.

Your PQube 3 also generates daily, weekly, and monthly trends/statistics reports automatically!

When equipped with compatible current transformers, your PQube 3 also records current waveforms, RMS amps, power and carbon. It measures watts, watt-hours, VAR's, power factor, and other power-related parameters.

It includes channels for measuring auxiliary voltages – typically 24V AC or 48V DC.

It also has a general-purpose digital input, which you can toggle with switch contacts or a logic signal, and a relay contact output, which opens for at least 3 seconds whenever your PQube 3 detects an event.

Your PQube 3 also measures and triggers on temperature, humidity and pressure at up to two locations, using optional ENV1 environmental probes using the USB ports under the Ethernet port.

2.1.2 What kind of software do I need?

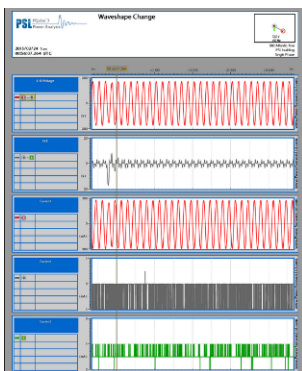

You don't need special software to use your PQube 3. It records all data on internal memory plus a removable microSD card, which can be read by any computer.

No special software is required – just open the GIF picture files with standard image programs, or even Microsoft Word® and Microsoft PowerPoint®, or open the CSV files with any spreadsheet program such as Microsoft Excel® (or OpenOffice.org Calc if you prefer something free).

Configure your PQube 3 with our free PQube Configurator program, or by editing a text file.

2.1.3 Which configurations are supported?

Your PQube 3 can monitor circuits anywhere in the world (single-phase all the way up to 3-phase). It supports nominal voltages up to 960VAC phase-to-phase (600 VAC phase-to-earth) and mains frequencies of 16.7 Hz, 50 Hz, 60 Hz, and 400* Hz. For medium and high voltage applications, your PQube 3 supports PT and CT ratios up to 50000:1.

Your PQube 3 can also be used to monitor DC voltage, which can be useful for solar applications (monitor the AC and DC voltages of your inverter).

*coming soon! Contact PSL for free firmware upgrade!

2.1.4 How do I power my PQube 3?

It can be directly powered from 24V AC or 24~48V DC or Power over Ethernet (PoE), or it can be equipped with an optional snap-in PM1 Module that operates from AC 100V ~ 240V, 50/60/400 Hz. You can also apply DC 120V ~ 370V too!

2.1.5 How do I communicate with my PQube 3?

No network is required to retrieve files from your PQube 3. Simply copy the data to your computer using a USB thumb drive or microSD card.

If you have a network connection available, your PQube 3 can automatically send you e-mails whenever it detects an event. You can send your PQube 3 a new setup file, or even update its firmware via e-mail. It also includes a built-in web server, FTP server, and supports communication protocols including MODBUS TCP/IP, SNMP and more, giving you many ways to communicate with your PQube 3.

2.2 How Is Your PQube 3 Different?



There are many power quality meters, energy meters, and energy recorders available. What makes the PQube 3 stand out from other products?

- **No software. No rental fees. Open data.** -- You don't need any software from PSL to use the PQube 3. Do you have a web browser? A text editor? A spreadsheet program like Microsoft Excel®? That's all you need! All the data that the PQube 3 records are in open formats that are easy to understand. You don't have to buy or lease software from Power Sensors Ltd, you don't have to pay us to see your data, and the files are easy to pass on to third parties.
- **Friendly data.** – When you need information about your electric power, you don't have time to learn how to use complex software to get the view that you want. You simply want your data organized and presented to you in a format you can understand. Your PQube 3 presents power quality events and trends in formats you can easily use and lays the data out in a way that's understandable. Your PQube 3 knows what's important.
- **Works out of the box, or configure everything to work for you** – With our patent-pending auto configuration, you can connect your PQube 3 to the power that you want to measure and the PQube 3 will immediately start recording data. If you don't like the default settings you can change almost any setting using the PQube 3 Configurator program, or by editing a text file on the SD card.
- **Works with or without a network** – Do you have an Ethernet network? Plug the cable into your PQube 3's Ethernet port and get emails when an event occurs, browse the recorded events and trends with your web browser, integrate it into your Modbus system, or send traps to your SNMP server. Don't have a network? No problem, just walk up to the PQube 3 and extract the data onto a USB thumb drive. You can look at all the files on any computer (you don't need proprietary software). You don't need a sophisticated centralized data collection system to get started. Just connect a PQube 3 and start getting data right away.
- **Store years of data on standard SD cards.** – Your PQube 3 comes with an 8GB microSD card which can hold up to 1 year of data under normal conditions. It automatically deletes the oldest data when it becomes full, so no maintenance is required!
- **Small size** – The PQube 3 is tiny (a little bit bigger than your fist), and that makes it easier to integrate into your equipment, enclosure, or electrical panel.
- **Great value** – At Power Sensors Ltd, we're experts at building power sensor electronics. We know how to do it right, and we know how to do it inexpensively. The PQube 3 provides high-end features at an affordable price.
- **It's everything you need.** – Power quality data: dips, swells, frequency variations, rapid voltage changes, voltage and current harmonics, high frequency emissions and high frequency impulses. Energy data: kWh, kVAh, kVARh, and carbon. Trend data: daily, weekly, and monthly strip charts, cumulative probability and load duration. Why buy multiple meters when your PQube 3 can do it all?

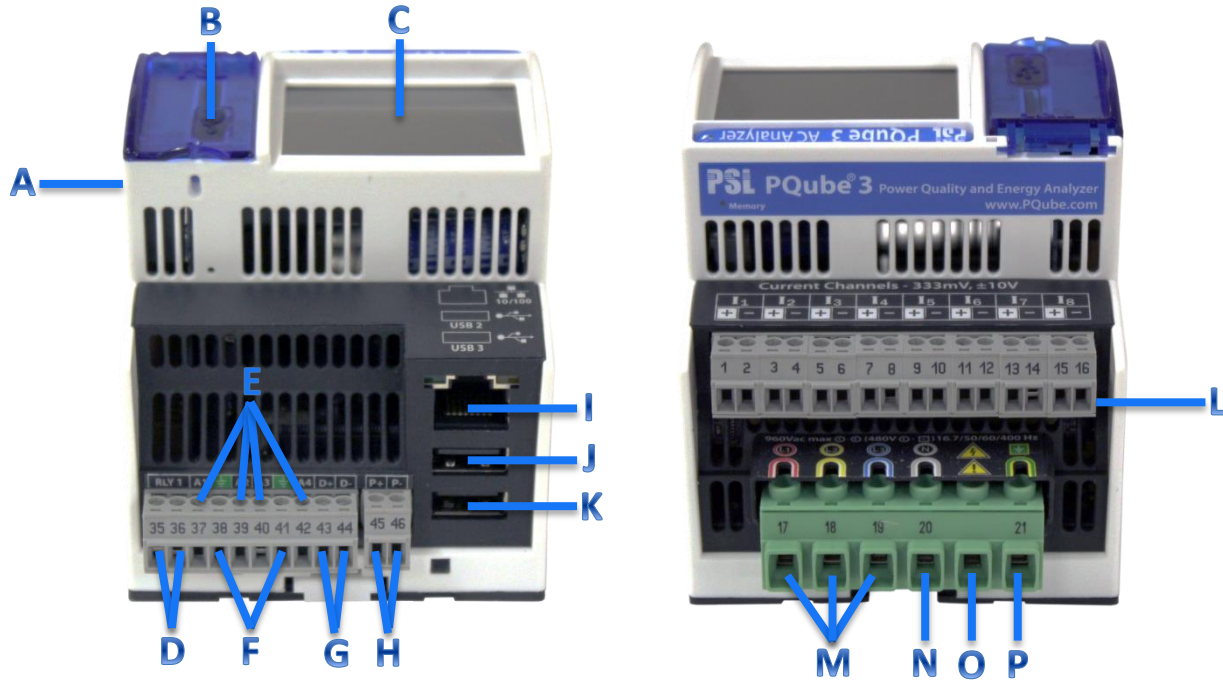
2.3 Overview of PQube 3 Ports, Connections, and Controls



A	Coin-cell battery (keeps real time clock alive when instrument power is lost)
B	USB-1 High-Speed USB 2.0 port for USB hard drives and adjacent microSD card slot (format using FAT32 filesystem)
C	Touchscreen display
D	Signal relay output. Normally closed during recording mode. Opens ½ cycle after event or device shutdown.
E	Analog inputs. Maximum ±60VDC or 33VAC to earth. Can be used as differential inputs.
F	Earth – functional. Use as a reference point for analog inputs (not needed if using analog channels in differential mode).
G	Digital input. Wetted with 2.4V at 3 microamps. 1.5-volt threshold. 60-volt tolerant.
H	Power supply input. 24VAC, or 24VDC to 48VDC (either polarity) nominal. 20VA max.

I	10/100 Ethernet RJ-45 port. 48V PoE compatible.
J	USB-2 Standard USB 1.0 port for use with ENV2 environmental probes.
K	USB-3 Standard USB 1.0 port for use with ENV2 environmental probes.
L	Current transformer inputs – nominal 0.333V RMS (LOW range) or ±10V _{pk} (HIGH range)
M	 L1, L2, L3 voltage inputs. See page 21 for maximum voltage ratings.
N	 Neutral terminal – optional depending on your power configuration
O	Not connected.
P	 Earth – functional. Used as the reference point for voltage measurements. IMPORTANT: this terminal must be properly connected to ground for safety, accuracy, and reliability.

2.4 Choosing Modules

IMPORTANT: Installation, service, and maintenance of your PQube 3 must only be done by qualified personnel for electrical installations.

Each PQube 3 comes standard with the following features:

- Three AC mains voltage channels
- Eight current channels (for CTs with 0.333V secondary)
- Four analog input channels for additional signals (for example, the output of a power supply)
- One digital input channel (monitor the state of an interlock switch)
- One signal output relay (notify your PLC that an event has occurred)
- Power supply input rated for 24VAC or 24-48VDC
- One 10/100 Ethernet port (PoE compatible!)
- One Hi-speed USB 2.0 port (for USB drive or ENV2 environmental probe)
- Two standard USB 1.0 ports (for ENV2 environmental probes)
- Full color touchscreen
- 8GB internal memory
- One 8GB microSD card
- One USB drive included with each PQube 3 (contains manual, quickstart guide, setup file, Configurator program, Report Writer program)

If you need additional functionality or inputs beyond the standard PQube 3 feature set, you can purchase optional modules for your PQube 3.

To choose modules for your application, you'll need to answer four simple questions:

- Do I need to power my PQube 3 from 100~240Vac (50/60/400 Hz)?
- Do I need battery backup in the event of a power outage?
- Do I need current inputs to measure the 1A or 5A secondary of a CT?
- Do I need ANSI Class 0.2 or IEC 62053-22 Class 0.2S revenue energy accuracy?
- Do I need ultra-precise GPS timestamps on your data?
- Do I want to record the environmental conditions such as temperature, humidity, pressure, or acceleration in addition to everything about the electric power?
- Do I need to measure full spectrum radiation using a Pyranometer?

2.4.3 Measure the 1A or 5A secondary wires of external current transformers

2.4.3.1 CTI-1A and CTI-5A

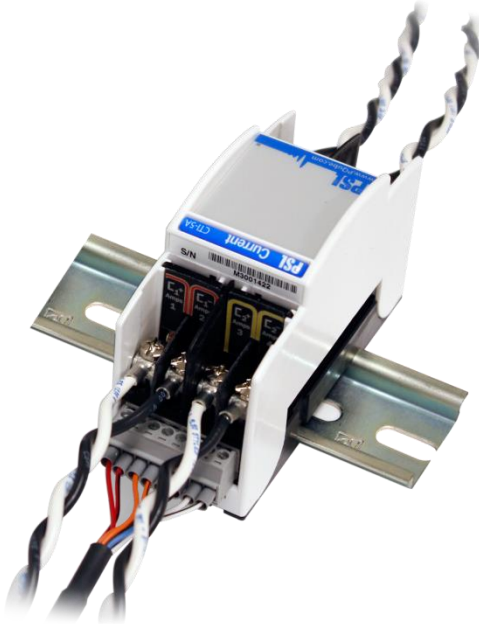

Your PQube 3 comes standard with 8 current channels which are compatible with CTs with 0.333V secondary.

But if you need to measure CTs with 1A or 5A secondary wires for your application, use the CTI Current Transformer Input module.

There are two versions; one with 1A input and one with 5A input. Use the CTI module that matches the secondary rating of your external CTs.

There are four current inputs per module. Your PQube 3 can accommodate up to two CTI modules.

Use this module if your application requires ANSI C12.20 Class 0.2 or IEC 62052-22 Class 0.2S revenue grade accuracy.

2.4.4 Measure Environmental Conditions

2.4.4.1 ENV2 Environmental Probe



The ENV2 environmental probe allows your PQube 3 to measure ambient temperature, humidity, pressure.

It also includes an accelerometer to measure shock and vibration, a thermocouple input for wide temperature ranges, and a solar irradiation input.

Connect up to 2 probes to your PQube 3 using a microUSB to USB cable.

You can use a USB cable with a length of up to 3 meters.

2.4.5 Synchronize your PQube 3 to GPS time

Your PQube 3 can synchronize its time clock to GPS, which provides better than 1 microsecond accuracy. This is useful for Class A measurements, or if you need to make phasor measurements with a microPMU.

2.4.5.1 MS1



The MS1 module interfaces with the GPS1 receiver to provide your PQube 3 with ultra-precise GPS timing.

2.4.5.2 GPS1



The GPS1 receiver locks onto GPS satellites in the sky to provide your PQube 3 with ultra-precise GPS timing. It is designed to be weather-resistant and you can install it outside using optional mounting hardware. It has 600V functional isolation at both ends of the cable for safety.

Connect the GPS1 receiver to your MS1 module using the included cable. You can extend the cable up to 25 meters using a female-female RJ-45 coupler and standard CAT5E cable.

3 Installing Your PQube 3

3.1 Installation Guide

3.1.1 Disconnect mains prior to servicing

IMPORTANT: Your PQube 3 must be installed only by qualified personnel for electrical installations.

Always disconnect all mains connections, and verify disconnections, prior to servicing.

In the United States and Canada, the equipment installation shall meet ANSI/NFPA 70, NEC, with CSA C22.1, CEC, Part I or with both as appropriate. In other countries, follow all local installation requirements and regulations.

3.1.2 Mount your PQube 3 properly and securely

Your PQube 3, and its optional modules, are designed to be mounted on an industry-standard 35mm DIN rail as rack- or panel-mounted equipment.

Example installation:



MS1 module on left side of PQube 3

PQube 3 (main module)

PM1/PM2 Module on right side of PQube 3

UPS1 Module on far right side

3.1.3 Include overcurrent protection and a disconnecting device

An external overcurrent protection device, such as a fuse or a circuit breaker, must be installed on each mains connection. **The device shall be UL Listed, branch circuit type overcurrent protector, rated max. 10A.**

Your PQube 3 can share the overcurrent protection device with other loads.

An operator-activated disconnecting device, such as a switch or a circuit breaker, must be installed on the mains connections. This device must be clearly marked as the disconnecting device for your PQube 3, and must be marked to indicate the disconnection function. Do not install your PQube 3 in such a way that it becomes difficult to operate this disconnecting device. The disconnecting device must not disconnect the earth connection. The disconnecting device should be installed near your PQube 3, within easy reach of the operator.

3.1.4 Protect the operator from the hazardous terminals

IMPORTANT: All high voltage parts must be covered, including the AC power to your PQube 3. Install your PQube 3 so that all of the screw terminal blocks are not ACCESSIBLE¹ to the operator. Your PQube 3 can also be installed without a cover if installed in a lockable IUL 508 control panel.

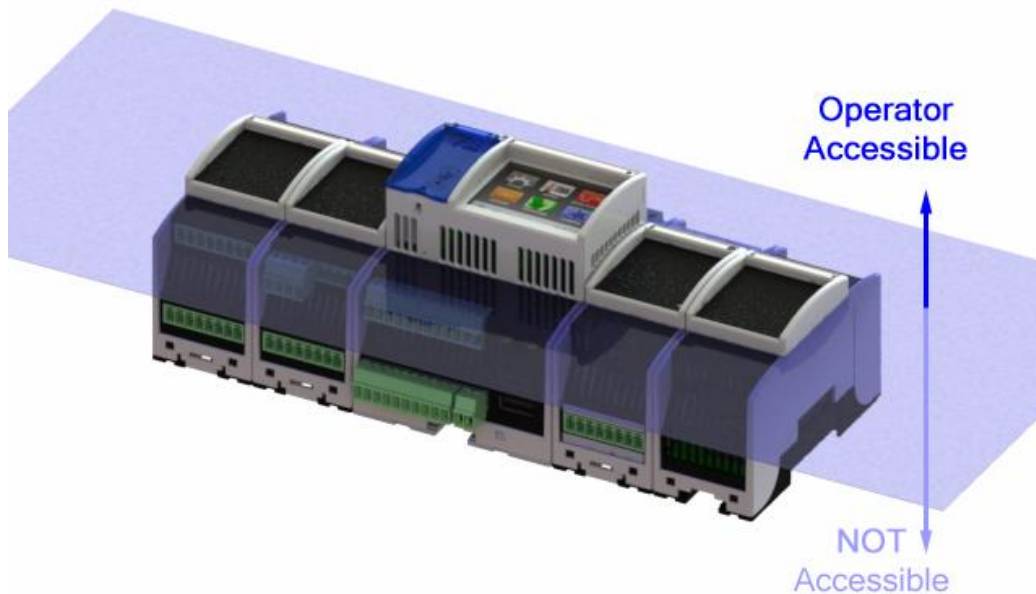

The operator must be protected from the hazardous screw terminal blocks by a barrier. The screw terminal blocks must be made "not ACCESSIBLE", as defined in UL /IEC 61010-1 6.2, using an enclosure or barrier that meets the rigidity requirements of UL /IEC 61010-1 8.1 and that requires a tool to remove.

¹ Accessible, as defined in UL 61010-1, means able to be touched with a standard test finger or test pin, when used as specified in UL61010-1 6.2.

If you choose to install your PQube 3 in an enclosure, select a UL-listed enclosure that is appropriate for the purpose. If you plan to use an enclosure of this type, you should review its mechanical compatibility with any optional features of your PQube 3 that you plan to use: optional USB connections, optional temperature-humidity probes, etc.



Note the 1-amp, 3-phase circuit breaker, at far right, used both as external overcurrent protection and disconnecting device, near your PQube 3.

3.1.5 Connect your PQube 3 to the power supply

Your PQube 3 can take its operating power from four different sources:

- 24VAC or ± 24 –48VDC power supply terminals on PQube 3
- Power over Ethernet (PoE)
- Optional PM1 Power Supply module
- Rechargeable UPS module (automatically provides up to 30 minutes of battery backup when the main power supply source drops out)

3.1.5.1 PQube 3 power supply terminals

The instrument power terminals (45 and 46) on the front of your PQube 3 must be connected to 24VAC ($\pm 20\%$) or 24–48VDC ($\pm 20\%$), supplied by a certified isolating power supply.

WARNING: Applying voltages outside of this range can cause permanent damage to your PQube 3.



Polarity does not matter. Also, your PQube 3 provides a minimum of 150V of transformer-based isolation between these terminals and all other terminals, eliminating any problems with ground loops.

3.1.5.2 Power over Ethernet (PoE)

Plug in an Ethernet cable leading to a 48V PoE source (PoE switch/hub/router or PoE injector).

If no other power sources are available, your PQube 3 will request power from the PoE switch.

If your PQube 3 is already powered from another source (24V power supply or PM1 power supply module, for example) then it will not request power from the PoE switch when you plug it in.

3.1.5.3 UPS1 Module

Plug the UPS1 module on the right side of your PQube 3 or PM1/PM2 module. This module is always the outermost module on the right side.

By default, the UPS timer interval is 3 minutes. However, you can choose the operating duration by writing a value in your **Setup.ini** file. The value can be set from 1 to 30 minutes. This guarantees that there will be enough charge in the battery to record several successive power interruptions.

As the lithium ion battery inside the module ages, its capacity will decline. Depending on operating conditions and requirements, it may be necessary to replace your UPS1 Module every 3 to 5 years or 500 cycles, whichever comes first.

3.1.5.4 PM1 or PM2 Power Supply Module

The PM1 or PM2 module accepts a range of 100~240VAC, 50/60/400Hz. It snaps into the right side of your PQube 3. This module is ideal for applications where 24-48VDC, 24VAC, and PoE are not available. Make sure your AC source can supply at least 20W.



PM2 front view – 24VDC output terminals



PM1/PM2 rear view - 100~240VAC input terminals



PM1 top view - 100~240VAC input terminals

On the PM2 module, 24VDC outputs are available on the 8-pin terminal block for powering external accessories including DC Hall Effect sensors and indication LEDs. The first pair of terminals labeled “Switched 24Vdc” can be toggled on and off in software. The other three pairs are tied together internally. The total combined power output is 5W. This is enough to power one additional PQube 3.

3.1.5.5 Maximum Load and Temperature Ratings

Your PQube 3 is rated for 65°C maximum ambient temperature under normal conditions when installed according to the procedures set forth in this manual.

However, when loading the PM2 module’s 24V auxiliary circuit with 5W, the maximum ambient temperature is derated to 55°C.

Power Source	Product Configuration	Auxiliary 24VDC load	Maximum USB Load	Maximum Load on Relay Outputs	Maximum Ambient Temperature
Instrument Power Terminals	PQube 3, MS1, GPS1	No load	USB1 1.5W USB2 0.5W USB3 0.5W	RLY1, RLY2, RLY3, RLY4 loaded with 30VDC/30VAC, 300mA max	65°C
PM1 AC Input Terminals	PQube 3, PM1, UPS1	5.15W max	USB1 0.3W USB2 0.1W USB3 0.1W	RLY1 loaded with 30VDC/30VAC, 300mA max	55°C
PM1 AC Input Terminals	PQube 3, PM1, UPS1, MS1, GPS1	No load	USB1 0.3W USB2 0.1W USB3 0.1W	RLY1 loaded with 30VDC/30VAC, 300mA max	65°C

3.1.6 Connecting the wires

Observe the wire size specifications and limitations. All conductors must be stranded copper. All conductors and insulation systems and crimped devices must be appropriate for the application. PSL recommends crimped ferrules on stranded wire. Tighten the screws on the high voltage terminal block to 0,5 newton-meters (5 inch-pounds) of torque. Observe all voltage ratings and limits.

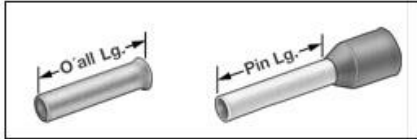

For connections, PSL recommends wire ferrules for stranded wire, such as Panduit F77 series, for example Panduit F77-6-M.



Figure 1: Your PQube meets all IEC requirements for high-frequency emissions and susceptibility, both conducted and radiated. For further protection, you can use clamp-on ferrites on signal cables to minimize radio-frequency emissions. For example, these are Panasonic KRCBC160928B and KRCBC130714B.

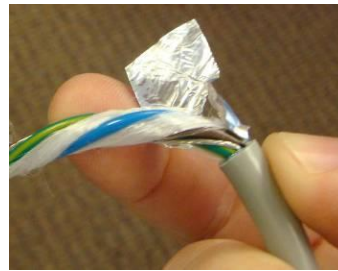







Figure 2: To minimize emissions with the optional PM1 Power Supply module, optionally use a shielded power conductor.

3.1.6.1 Conductor characteristics

Connection	Minimum wire size	Maximum wire size	Limitations and remarks Comply with all local safety and installation requirements and regulations.
PQube 3 terminals L1, L2, L3, N	20AWG (0,52 mm ²)	14 AWG (2.1mm ²)	Min 600V UL-recognized insulation system required. These terminals require less than 0,01 amps. Connection to N (15) is optional. For single phase monitoring, connect either L1-N or L1-L2 as appropriate for the mains configuration.
PQube 3 Earth terminal	20AWG (0,52 mm ²)	14 AWG (2.1mm ²)	Connect this terminal to a suitable earth connection. For proper PQube operation, you must connect this terminal to earth. It is used as a measurement reference, and as a reference for your PQube's low voltage circuits.
Optional PQube 3 terminals	20AWG (0,52 mm ²)	14 AWG (2.1mm ²)	Min 600V UL-recognized insulation system required. Wire size must be adequate for relay contact load. These terminals rated at 30 VAC max, 60 Vdc max, 2 amps max.
All other terminals	20AWG (0,52 mm ²)	14 AWG (2.1mm ²)	Min 600V UL-recognized insulation system required.
PM1 AC Input terminals	20AWG (0,52 mm ²)	14 AWG (2.1mm ²)	Min 600V UL-recognized insulation system required. Shielded cable recommended for minimizing emissions.
PM1 DC Output terminals	20AWG (0,52 mm ²)	14 AWG (2.1mm ²)	Min 600V UL-recognized insulation system required

3.1.6.2 Maximum voltages

Connection	Measurement Category	Maximum current	Limitations and remarks
PQube 3 terminals L1, L2, L3, N 	600 Vrms, CAT III		 Corresponds to 480V L-N / 830V L-L max for 3-phase, 4-wire Wye/Star systems. Corresponds to 600V L-L max for 3-phase, 3-wire Delta systems. Corresponds to 480V L-L max for 1-phase, 2-wire Single Phase systems. Corresponds to 480V L-N / 960V L-L max for Split-Single-Phase, 3-wire systems. All voltage channels must be covered after installation.
	300 Vrms, CAT IV		Corresponds to 277 L-N / 480V L-L max for 3-phase, 4-wire Wye/Star systems. Corresponds to 480V L-L max for 3-phase, 3-wire Delta systems. Corresponds to 240V L-L max for 1-phase, 2-wire Single Phase systems. Corresponds to 240V L-N / 480V L-L max for Split-Single-Phase, 3-wire systems. All voltage channels must be covered after installation.
PQube 3 Earth terminal 	N/A		
Optional PQube 3 RLY terminals	30 Vrms or 60 Vdc	0.3A	
All other PQube 3 terminals	30 Vrms or 60 Vdc		
PM1 AC input terminals 	240 Vrms, CAT II		 Rated for Single-Phase 100~240VAC max. AC voltage input terminal must be covered after installation.
PM1 DC output terminals	24 VDC	0.42A	10W maximum output
USB1 Input	5VDC	0.2A	
USB2 and USB3	5VDC	0.1A	

Note: "CAT III" means Measurement Category III as defined in UL / IEC 61010-1: "Measurement category III is for measurements performed in the building installation.... Examples are measurements on distribution boards, circuit-breakers, wiring, including cables, bus-bars, junction boxes, switches, socket-outlets in the fixed installation, and equipment for industrial use..."

"CAT IV" means Measurement Category IV as defined in UL / IEC 61010-1: "measurements performed at the source of the low-voltage installation.... Examples are electricity meters and measurements on primary overcurrent protection devices and ripple control units."

3.1.7 Connect mains AC voltage wires



The large high voltage terminal block on the back of your PQube 3 is removable. Refer to the wiring diagrams on page 29 and use the appropriate wiring scheme for your power configuration.

IMPORTANT: Don't forget to install the Earth conductor. Your PQube 3 relies on the Earth conductor for safety, reliability, and accuracy.

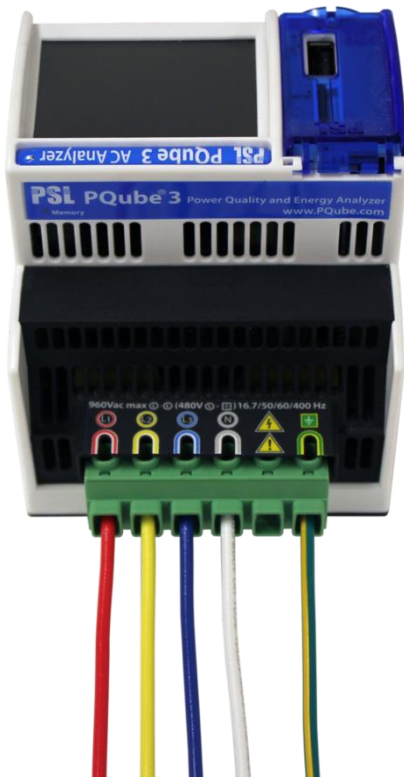

You must apply at least 30VAC to these terminals before your PQube 3 will begin recording.

3.1.8 Protect antenna terminals from lightning

If you install an antenna in an outdoor location where it may be exposed to lightning, you must include a properly installed UL-497C-listed lightning protection device on the antenna cable and the antenna must be reliably earthed. Follow all local installation safety requirements and regulations.

3.1.9 Installing Your PM1 Power Supply Module



PQube 3

PM1

The optional PM1 Power Supply Module connects to the right side of your PQube 3; just snap it in. It accepts any 50/60/400 Hz single-phase input between 100Vac and 240Vac nominal. Verify that you are connecting the line and neutral wires to the correct terminals on the module.

3.1.10 Installing Your UPS Module



PQube 3

PM1

UPS1

The UPS Module provides backup power to your PQube 3 in the event of complete loss of instrument power. Plug it into the right-side of your PQube 3. If using a PM1 Power Supply Module, plug the UPS module into the right side of the PM1 module. The lithium-ion battery pack can provide power between 1 and 30 minutes (user-configurable).



3.1.11 Installing Current Transformers (CTs)

Your PQube 3 records AC current by measuring the secondary circuit of a current transformer (CT).

When installing current transformers, it is important to match the phases to the voltage inputs and current input (connect the L1 voltage input and the L1 current sensor to the same conductor). This is necessary for correct power and energy calculations.

Instructions for setting your CT ratio can be found on page [38](#).

IMPORTANT: You must only use UL listed energy monitoring current transformers with your PQube 3.

A note on choosing the appropriate range of CT's for your application:

If the PQube 3 is installed to monitor power and load, the nominal rated current of the CT should be the most common load current throughout the consumption period (e.g. work days). Your PQube 3 makes current measurements with a Crest Factor of 3.5. This means that your PQube 3 can measure instantaneous currents up to 350% of the nominal rated current (for example, if you have selected a 300-amp current transformer, your PQube 3 will accurately measure up to ± 1050 amps instantaneous). This is a very useful feature when dealing with inrush currents, and currents with high harmonic contents.

If the PQube 3 is installed to troubleshoot circuit breaker trip operation, the nominal rated current should be selected closer to the trip settings. In all cases the PQube crest factor of 3.5 provides a margin to capture properly the peak currents.

3.1.11.1 PSL Ultra-Precise CTs

PSL Ultra-Precise CTs are specifically designed for your PQube 3. They are calibrated to match the input impedance of your PQube 3's current input channels, and each CT comes with its own NIST-Traceable calibration certificate and table which you can upload to your PQube 3. This is important if you need to measure high-order current harmonics or if you need revenue-grade accuracy for your application.

PSL Ultra-Precise CTs are UL listed and utilize a 0.333V secondary to match your PQube 3's current input terminals. A burden resistor is built into the CT so you do not need to worry about hazardous open circuit voltages.

You can see the list of available PSL Ultra-Precise CTs for your PQube 3 here:

<http://www.powersensorsltd.com/CTOption3.php>

You can look up the calibration certificate for your CTs here:

<http://www.powersensorsltd.com/CalibCerts3.php>



3.1.11.2 Installing CTs with 0.333V secondary

Your PQube 3 comes standard with 8 current input channels, which are typically used to measure L1, L2, L3, N, E, plus 3 additional single-phase channels. The current channels on your PQube 3 are rated for 0.333V nominal input, and they are designed to be used with CTs with 0.333V secondary.

For PSL CTs, white wires are positive and black wires are negative.

If using PSL Ultra-Precise CTs with the shielded secondary wires, red is positive and black is negative. Connect the shield conductor to ground. If using another manufacturer's CTs, verify which wires are positive and negative before installing them.



Clamp the CT around the conductor. For all PSL CTs, the label faces towards the source.

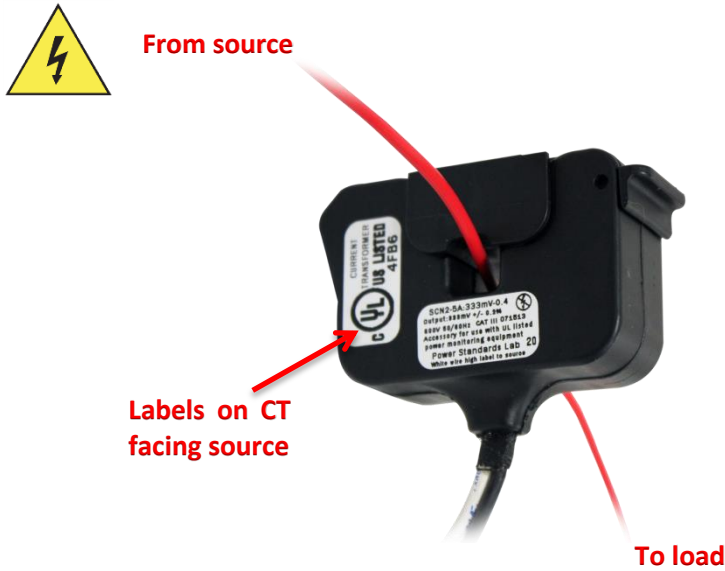

3.1.11.3 Installing CTs with 1A or 5A secondary

If you will be monitoring the 1A or 5A secondary of existing metering CTs, you will need to use the CTI-1A or the CTI-5A module. They have 1A and 5A nominal inputs, respectively.

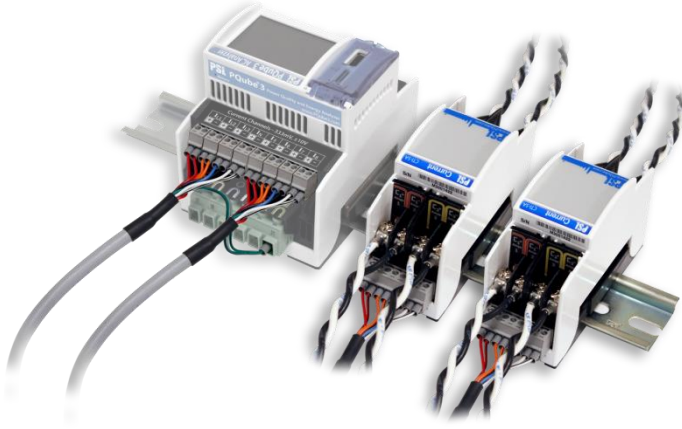

The CTI module inputs are installed in series with your 1A or 5A secondary circuit. The terminal block on your CTI module is connected to the 0.333V current input channels on your PQube 3. Each CTI module includes 4 current channels, so you can use up to 2 CTI modules per PQube 3.

WARNING: When installing CTs with 1A or 5A secondaries, take extra precautions to ensure that an open circuit does not develop on the secondary wires. Shorting blocks are typically used to avoid the possibility of an open circuit during installation. CTs must be installed only by a qualified personnel for electrical installations.

1A or 5A vs. 0.333V secondary, what's the difference?

Most current transformers are designed to have 1A or 5A of current flowing through the secondary circuit while full rated current is flowing through the primary circuit.

While installing CTs with 1A or 5A secondary, it is imperative that an open circuit does not develop in the secondary. If an open circuit develops while current is flowing through the primary of the CT, a very hazardous open circuit voltage (OCV) will develop across the opening. In this condition, typical OCV values can range from hundreds to thousands of volts.

For this reason, PSL offers CTs exclusively with 0.333V secondary. Our CTs include a built-in burden resistor in the secondary circuit so that the current always has a path to flow through. The resistor value is calibrated and tuned to achieve a 0.333V drop across the resistor at full rated current. This 0.333V signal can then be measured using the 2 wires coming out of the CT.

3.1.12 Connecting the ENV2 environmental probes

ENV2 probes are interfaced through a USB cable. Insert the USB connector into the USB-2 and USB-3 slots of the PQube. You can connect up to 2 probes to your PQube3.

Note: if necessary, the probe can be connected to the front USB-1 slot, but you cannot extract data over USB while the probe is occupying this port.

You can verify the proper operation of the environmental probe by checking the meter on the screen (see Chapter "Operation" - touch screen - meters).



3.1.13 Installing Your MS1 Sync Module (GPS option)

The optional MS1 Sync Module connects to the left side of your PQube 3; just snap it in. Connect the module before supplying power to your PQube 3. The MS1 Sync Module interfaces with the PSL GPS1 module using a special 8-pin cable at the MS1 module and an RJ45 connection at the GPS1 receiver.

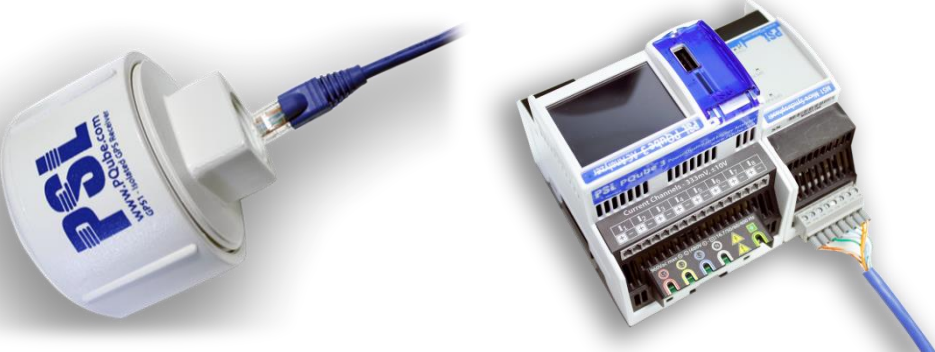

3.1.13.1 MS1 module to GPS1 receiver 8-pin cable pinouts:

MS1 Pin-Out with pin 1 on left while looking at module from the front				GPS Receiver Pin-Out based on standard RJ-45 Ethernet pin-out			
Pin #:	Net Name:	Function:	Wire Color*:	Pin #:	Net Name:	Function:	Wire Color*:
1	ANT_PPS-	Pulse Per Second -	Orange/White	1	ANT_PPS-	Pulse Per Second -	Orange/White
2	ANT_PPS+	Pulse Per Second +	Orange	2	ANT_PPS+	Pulse Per Second +	Orange
3	ANT_RX-	Received Data -	Green/White	3	ANT_RX-	Received Data -	Green/White
4	ANT_TX+	Transmitted Data +	Blue	4	ANT_TX+	Transmitted Data +	Blue
5	ANT_TX-	Transmitted Data -	Blue/White	5	ANT_TX-	Transmitted Data -	Blue/White
6	ANT_RX+	Received Data +	Green	6	ANT_RX+	Received Data +	Green
7	ANT_COM	Power Supply Return	Brown/White	7	ANT_COM	Power Supply Return	Brown/White
8	ANT_25V	Positive Power Supply	Brown	8	ANT_25V	Positive Power Supply	Brown

*Wire color is based on standard Ethernet cable used to interface between MS1 Module and GPS1 Receiver.

IMPORTANT: Do not connect the RJ-45 plug of your GPS cable into a network switch or router. It will damage your networking equipment.

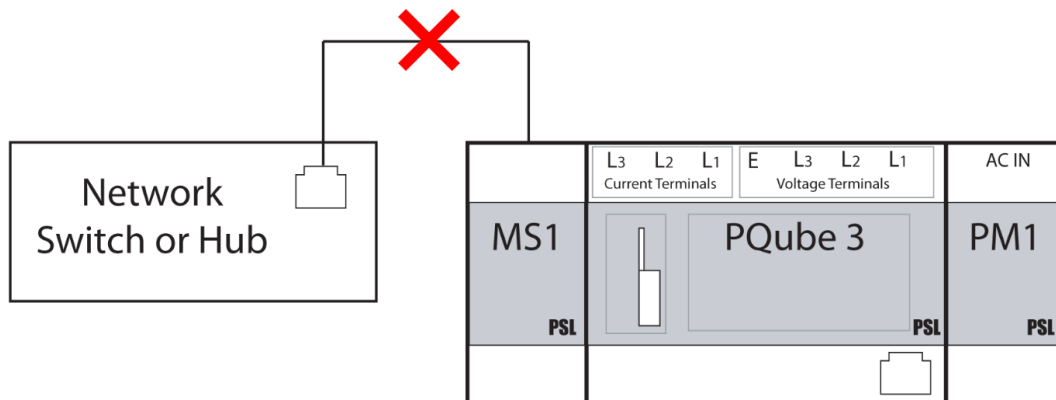

3.2 Wiring Diagrams

3.2.1 Single Phase L1-N

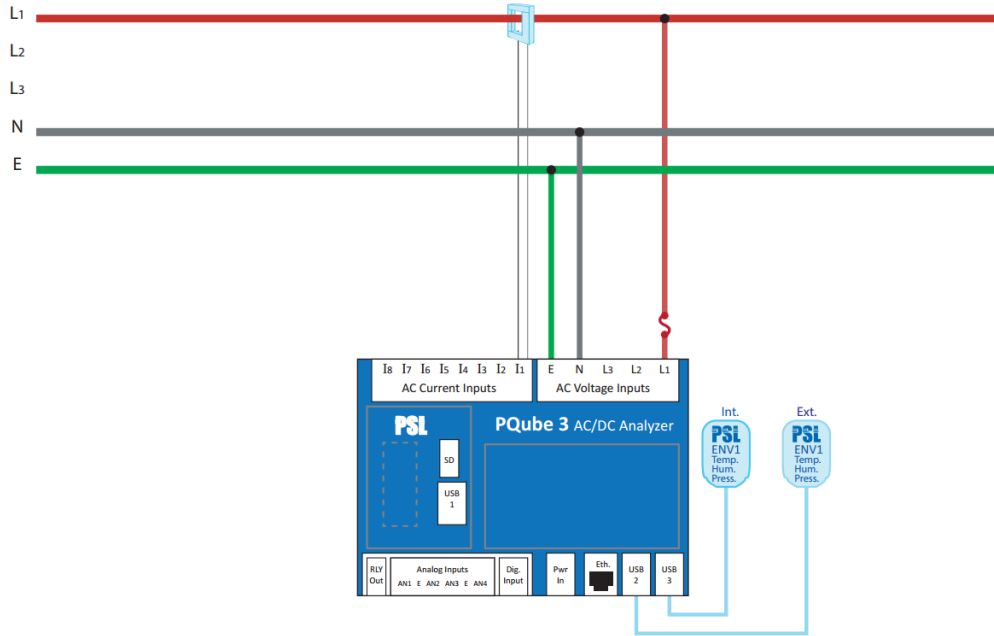

3.2.2 Single Phase L1-L2

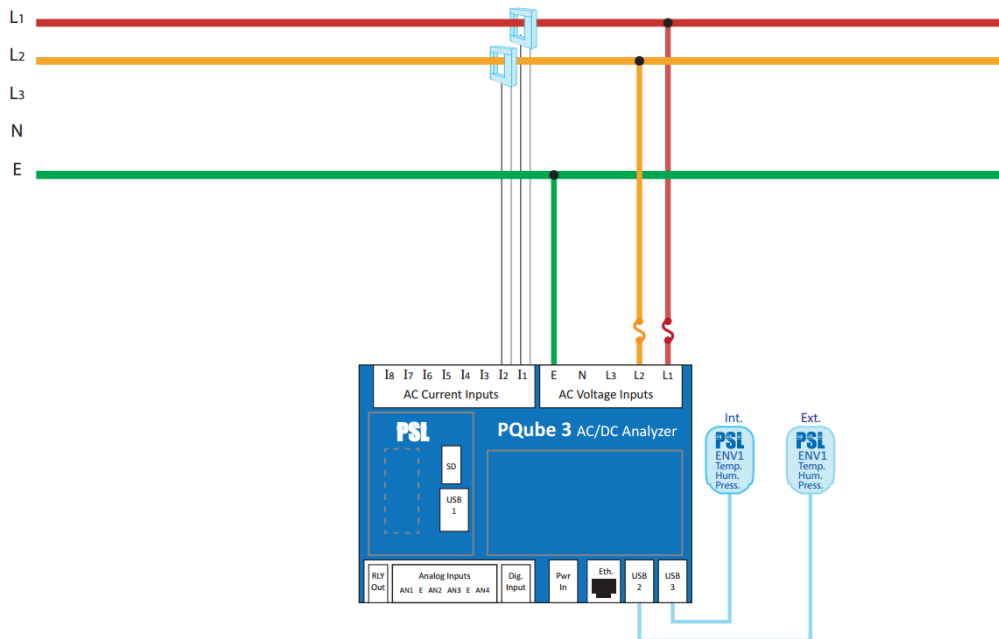

3.2.3 Single Split Phase

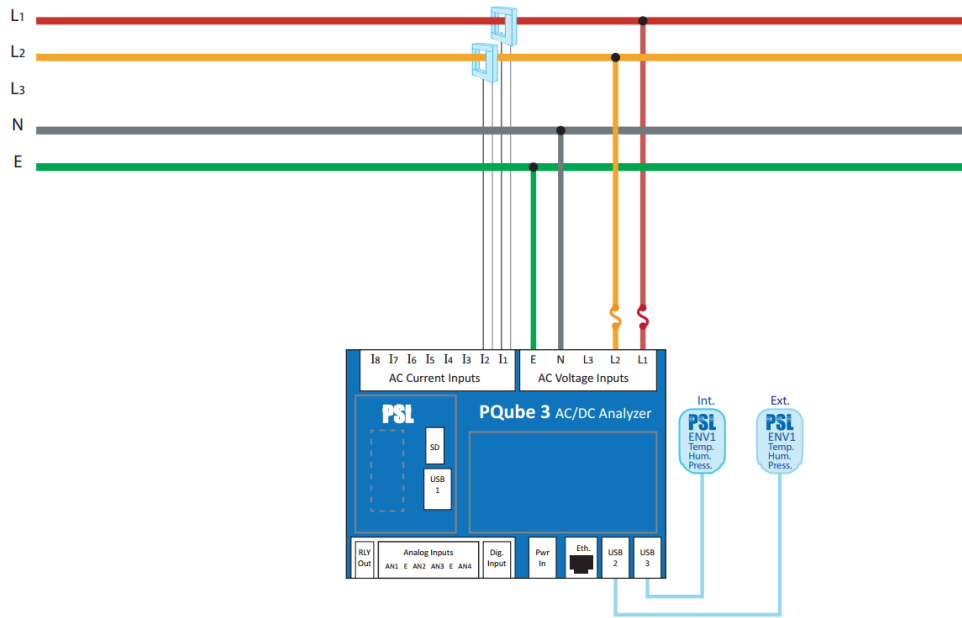

3.2.4 Delta – 3 CTs

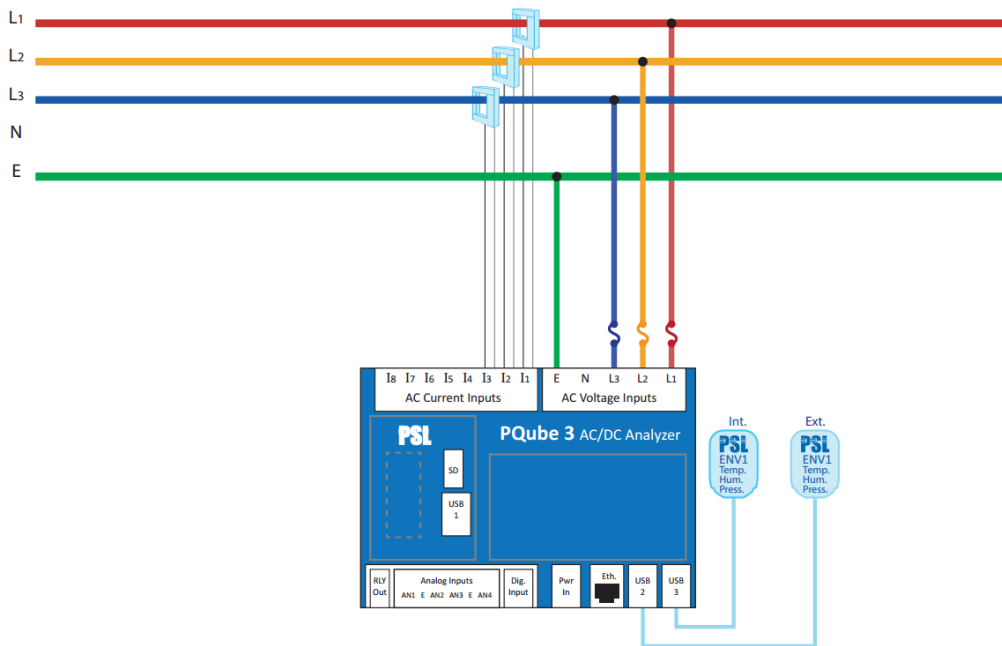

3.2.5 Delta – 2 CTs (PQube 3 calculates current on remaining channel)

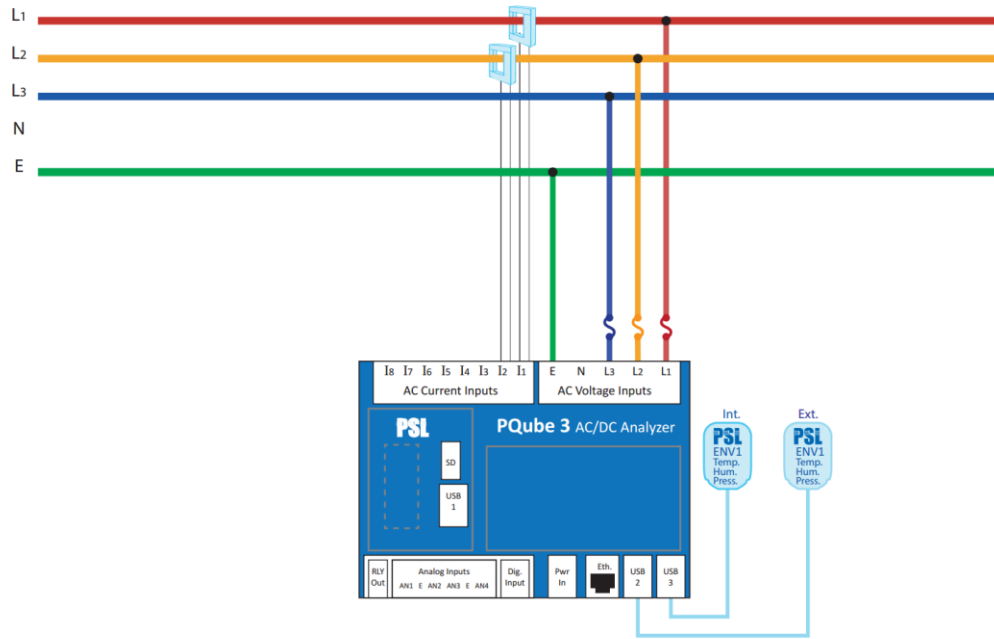

3.2.6 Wye/Star

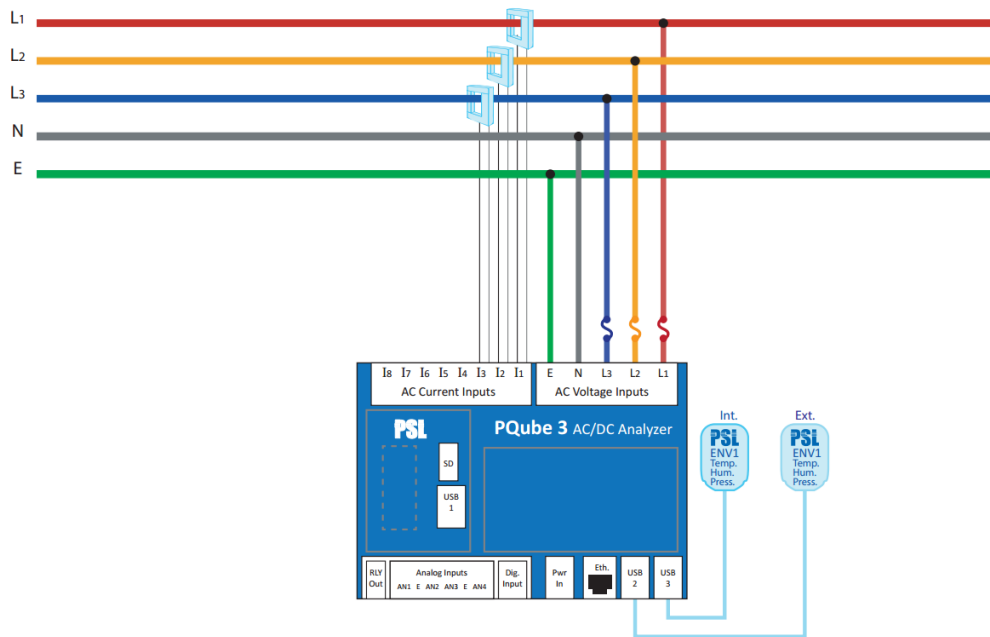

3.2.7 Measuring Neutral Current (applies to any power configuration with Neutral)

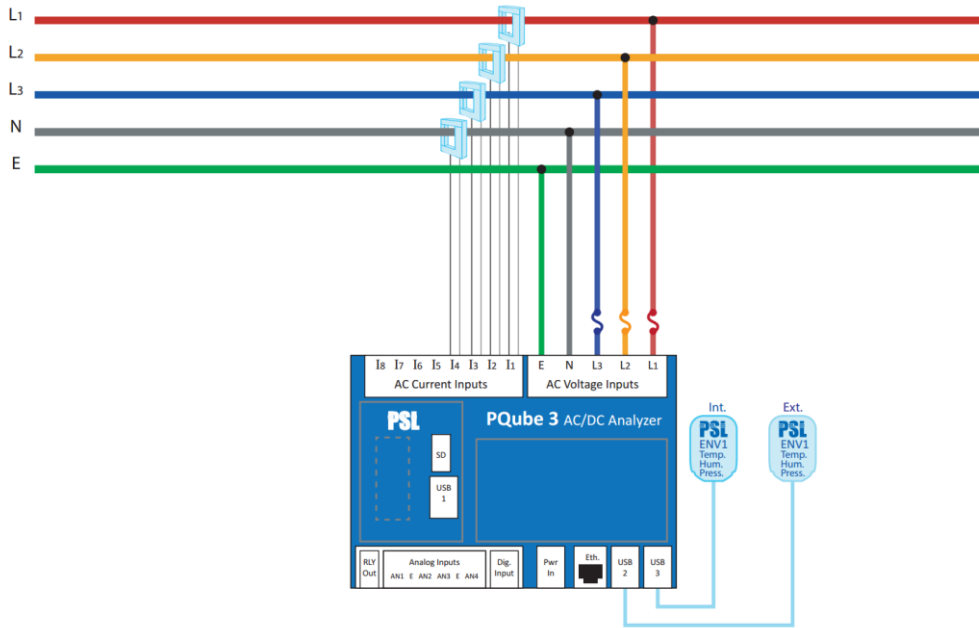

3.2.8 Measuring Earth Current (applies to any power configuration)

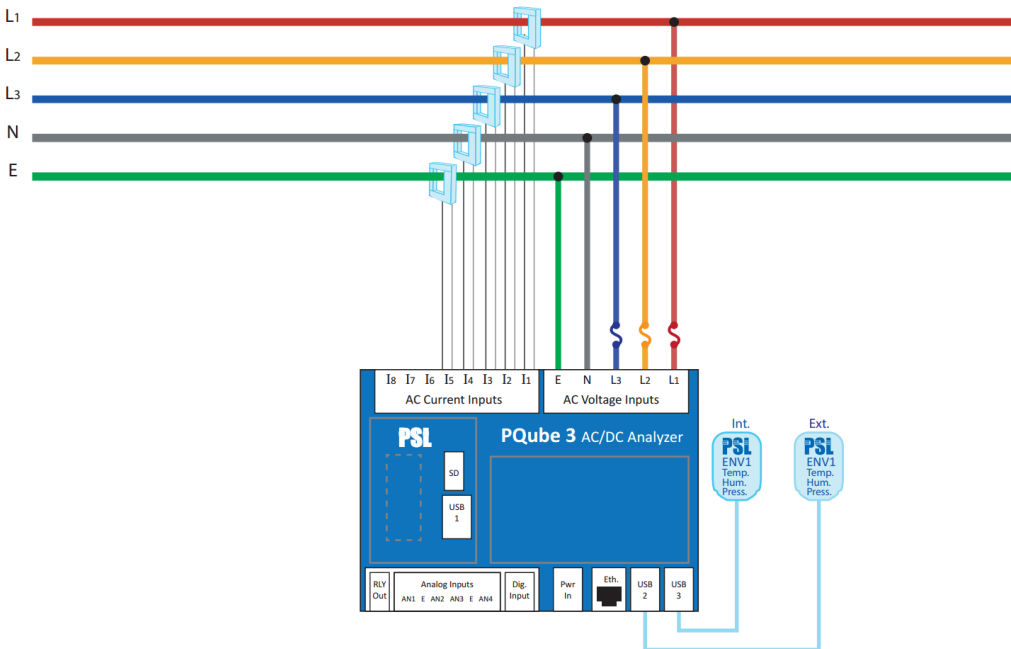

3.2.9 Measuring Net Earth Current – Delta

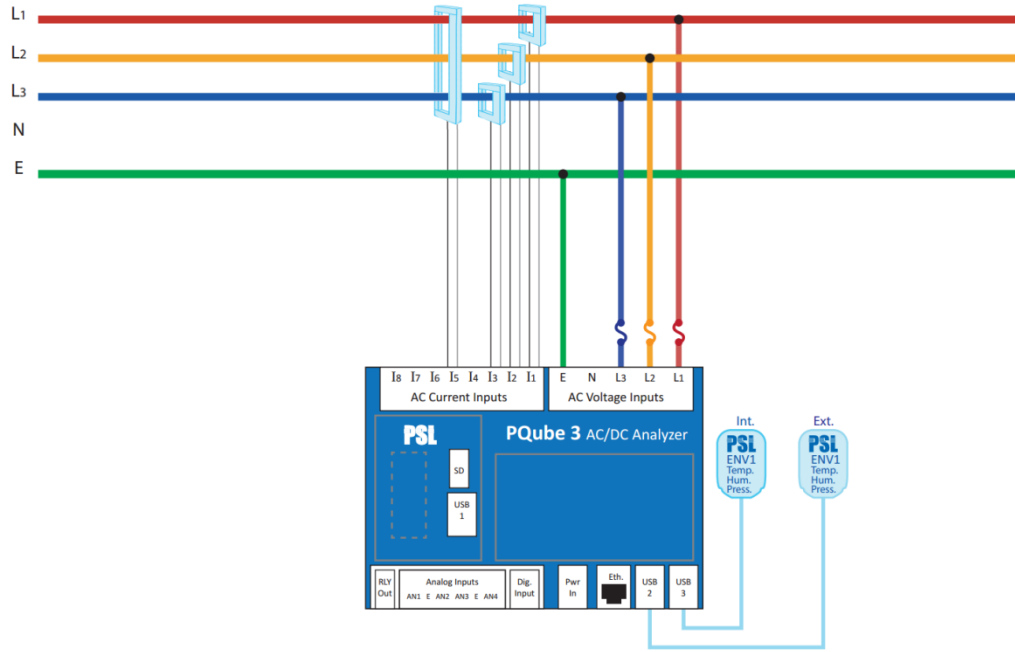

3.2.10 Measuring Net Earth Current – Wye/Star

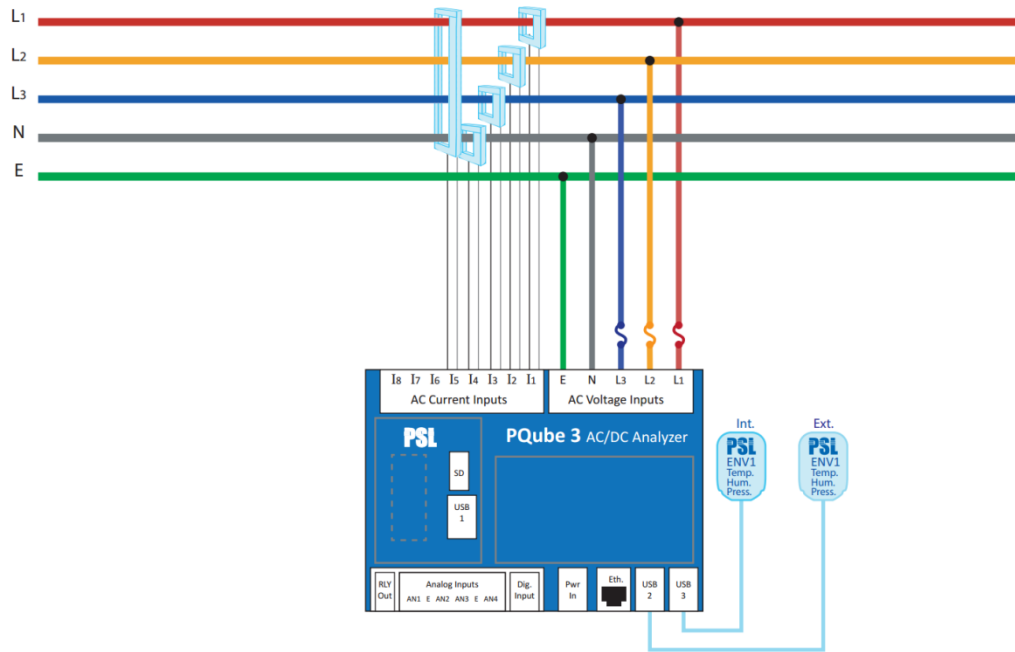

3.3 Low Voltage Input/Output Terminals

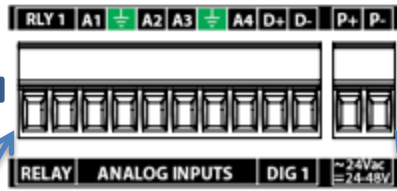
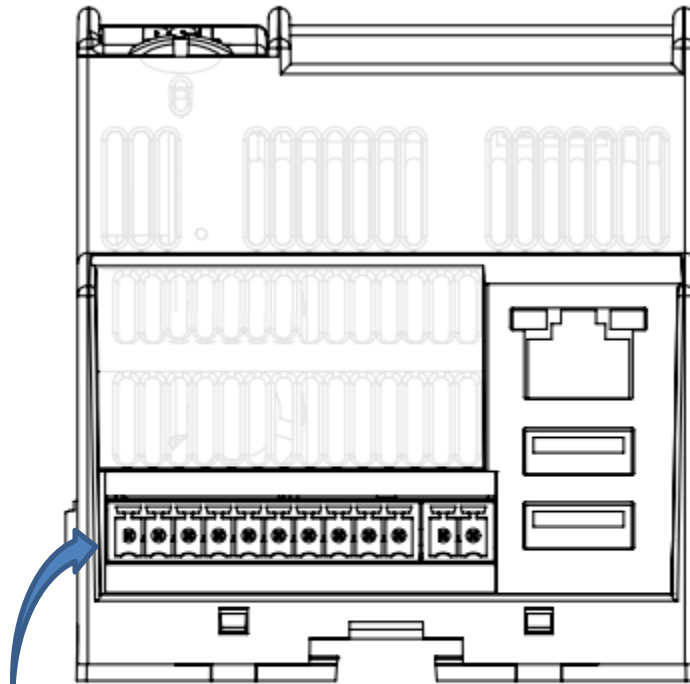

Phoenix Contact MC 1,5/10-ST-3,5 - 1840447

Phoenix Contact MC 1,5/ 2-ST-3,5 - 1840366

4 Setting Up Your PQube 3

4.1 Your Setup File

All of your PQube 3's settings are contained in a simple text file called **Setup.ini**.

The factory-default setup file can be found on the USB drive that shipped with your PQube 3.

You can retrieve your PQube 3's existing setup file via USB, SD card, email, web, or FTP.

Edit it using the PQube 3 Configurator program (recommended for most users). It is a graphical editing utility to help avoid mistakes and possible conflicts across settings. For advanced users, you can edit it using a text editor like Notepad.

You can download the PQube 3 Configurator program for free here:

<http://www.powersensorsltd.com/PQube3.php#config>

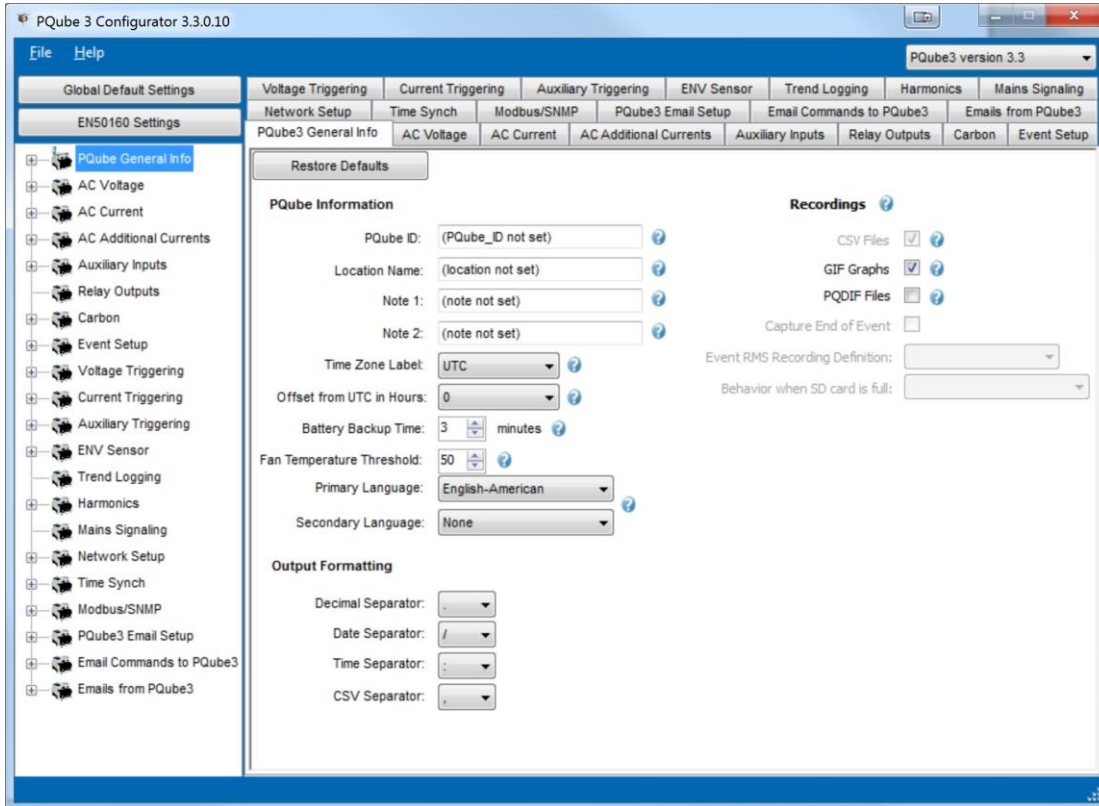

After you've made your changes, save the file as **Setup.ini** and upload it back to your PQube 3 via email, web, FTP, and it will automatically reboot and load the new settings on startup. You can also copy your new Setup file onto a USB drive or microSD card and insert it directly into your PQube 3. After detecting the new Setup file, your PQube will ask you to reboot so it can load the new settings.

For details about each of the Setup file tags, refer to Appendix 1 on page [70](#).

4.2 Initial Device Setup

Your PQube 3 will work right out of the box. Once your PQube 3 has been installed, connected to the monitoring circuit, and powered on, it will begin recording data immediately. The default settings will work for most applications, but if you have special requirements you may need to change a few settings. Don't worry, it's an easy process.

4.2.1 Set the Date and Time

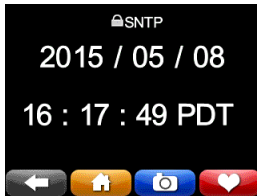

After your PQube 3 is installed and running, the first thing you need to do is set the date and time. Setting the date and time is important because all of the output files your PQube produces include a time stamp.

All PQubes are shipped from the factory synchronized to UTC time.

If your PQube 3 has an internet connection, you can configure it to synchronize to an SNTP or NTP server in the Setup file.

If your PQube 3 is equipped with the MS1 and GPS1 modules, it will automatically synchronize its clock to GPS time.



If your PQube 3 does not have GPS and is not configured for SNTP or NTP, you can manually set the time using the controls on the display.

4.2.2 Set Your Languages

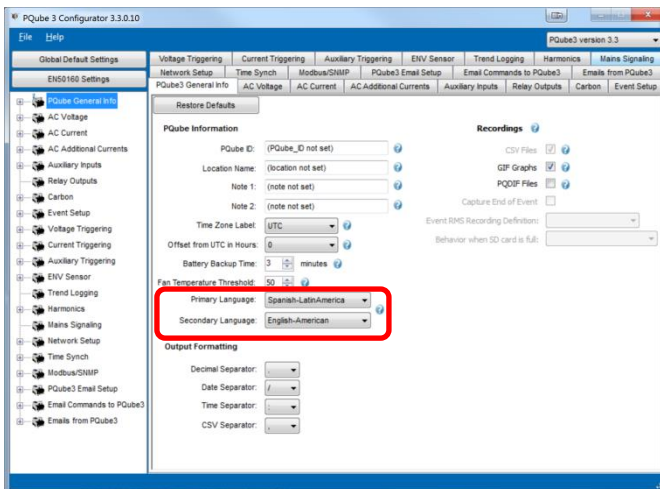

Specify a primary language and secondary language in your Setup file. Events and trends will be generated using both languages.

You can also choose which language shows up on the display from the Languages screen on the display.



4.2.3 Set Your Potential Transformer (PT) Ratio

If you are using Potential Transformers (PT) to monitor voltages above 690Vac Phase-to-Phase (400Vac Phase-to-Earth) you can program the PT ratio into your PQube 3 so that it reports the actual primary voltage.

For example, to use your PQube 3 on a 24 kilovolt distribution system, you might use a 100:1 potential transformer to reduce the 24 kilovolts to 240 volts.

In setup file, set the PT ratio to 24000:240 or 100:1. You will also need to set your nominal voltage using the primary voltage of your PT. Even though your PQube 3 has 240V applied to its mains AC voltage terminals, you need to set the nominal voltage to 24000.

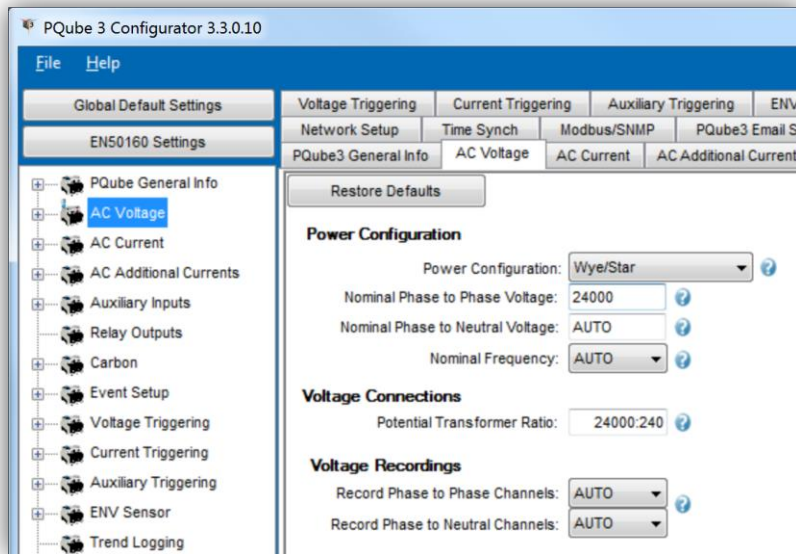

4.2.4 Set Your Current Transformer (CT) Ratio

4.2.4.1 If you are using CTs with 0.333V secondary

To set the CT ratio, simply enter the primary current and secondary voltage into your CT ratio. For example, if you have a current transformer rated at 300 amps, with 0.333V secondary, then you would set your CT ratio to 300:0.333. The value in the **Current Transformer Ratio** field is applied to the L1, L2, and L3 current channels.

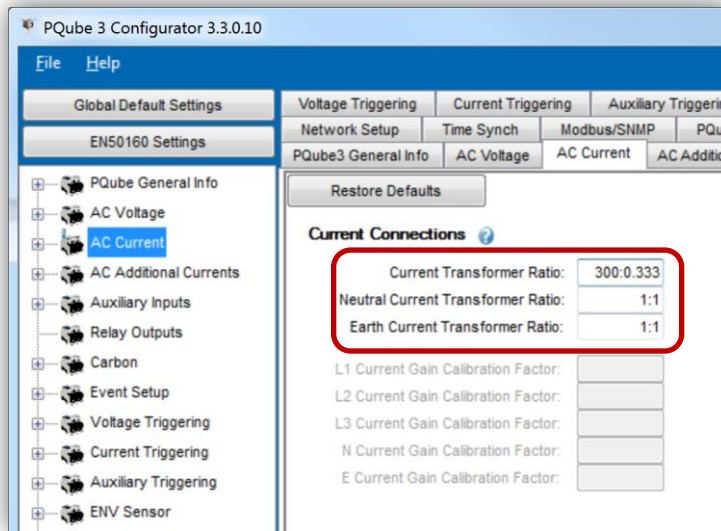

4.2.4.2 If you are using CTs with 1A or 5A secondary

Use the CTI-1A or CTI-5A modules are designed to accept the 1A or 5A secondary of metering CTs.

The CTI-1A module has a ratio of 1A:0.333V. The CTI-5A module has a ratio of 5A:0.333V.

To calculate your CT ratio, multiply the ratio of your metering CT by the ratio of your CTI module.

	CT Ratio	CTI Module	CT Ratio Calculation	CT Ratio in Setup File
Example 1	300A:5A	CTI-5A module	$\frac{300A}{5A} \times \frac{5A}{0.333V} = \frac{300A}{0.333V}$	300:0.333
Example 2	300A:5A	CTI-1A module	$\frac{300A}{5A} \times \frac{1A}{0.333V} = \frac{300A}{1.666V}$	300:1.666
Example 3	300A:1A	CTI-5A module	$\frac{300A}{1A} \times \frac{5A}{0.333V} = \frac{1500A}{0.333V}$	1500:0.333

4.2.5 Verify your PQube 3 has been configured correctly

4.2.5.1 Check Power Configuration

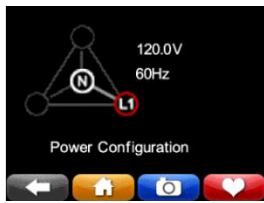

From the main menu on the touchscreen display, go to System, Config, Power Config. Verify that the power configuration, nominal voltage, and nominal frequency look correct. This is important for proper event detection and data recording. Your PQube will not begin recording until it has locked onto the power configuration. The minimum lock-on voltage is 30VAC applied between L1 and N, or between L1 and L2.

If you are using your PQube for DC monitoring only, and do not wish to record AC voltage, you can set your Power Configuration to "NO_MAINS" in your setup file.

4.2.5.2 Verify meter readings



From the display, press the Meters button and check that everything looks correct. If you entered PT and CT ratios into your setup file, verify that your voltage and current values look appropriate. Also make sure that your values for power (watts) and power factor look appropriate. If you have inverted your CTs or installed the CTs on the wrong phases, your power readings will be inaccurate.

4.2.5.3 Verify voltage and current vectors

You will also want to verify that your voltage and current vectors look appropriate. Our vector convention for a balanced 3-phase system is L1 voltage at 0° , with L2 voltage at -120° and L3 voltage at $+120^\circ$.

4.2.6 Common Installation Errors

4.2.6.1 Negative Sequence Unbalance Excessively High

If your PQube 3 reports an excessively high negative sequence unbalance ratio, this means your phase rotation is reversed. If you were connecting a 3-phase motor using this sequence, it would begin rotating in the opposite direction as intended. To change your phase rotation, swap any 2 phases.

4.2.6.2 Power Readings Lower Than Expected

If your watts and power factor readings are much lower than expected, double check that your CTs are installed on the correct conductors. For example if your L1 current sensor is installed on the L2 conductor, your L1 power will be much lower than expected, and possibly negative.

4.2.6.3 Unexpected Negative Power Readings

During installation, it is easy to make a mistake in your current transformer connections, either by reversing the secondary connections or by feeding the main power conductor through your current transformer backwards.

Why Bother?

It is important to correctly connect your CTs (or use the method above to correct a wiring error). Power (watt) calculations are made by multiplying the instantaneous current by the instantaneous voltage. If one or more of your current transformers is incorrectly set up, your PQube will calculate negative power for that phase.

You can always shut the power down and open up the cabinet to fix your wiring; but an easier way is to invert your CT polarity in your setup file.

For example, if you realize that you have installed your L2 current transformer backwards, just invert the L2 current channel in your setup file.

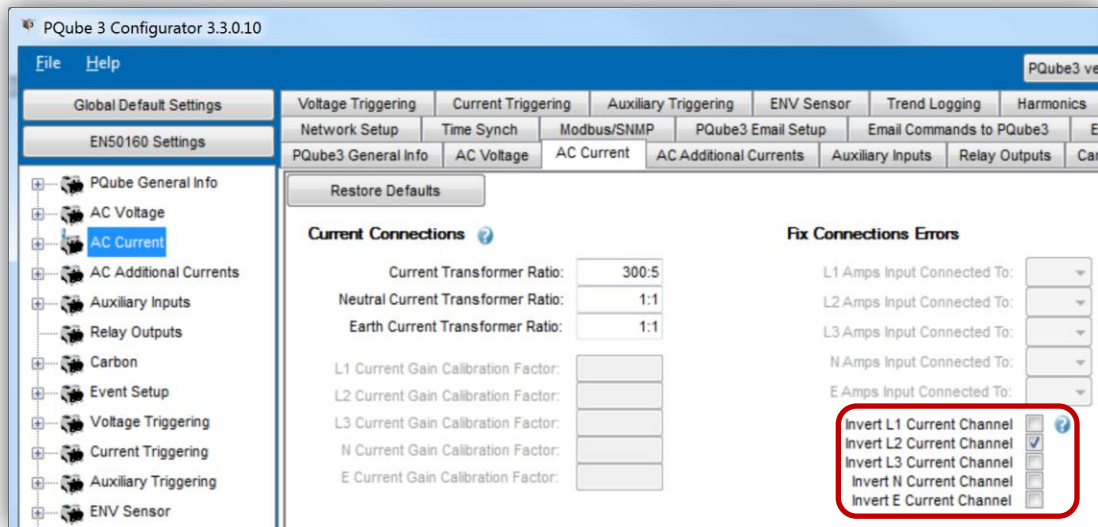

4.2.6.4 PQube 3 Not Locking Onto Power Configuration

Your PQube 3 does not have an ON/OFF switch for recording data. It is designed to automatically begin recording data as soon as it has locked onto the power configuration. If it cannot lock onto a power configuration, it cannot record data.

If your PQube 3 is having trouble locking on, check the following:

First, verify that you have at least 30VAC applied between the L1 and N terminals or the L1 and L2 terminals.

Next, verify that you’ve connected the Earth conductor to your PQube 3. If you forget to install the Earth conductor to your PQube 3, your PQube 3 may have problems locking onto the power configuration. Connecting the Earth conductor is required to ensure the safety, reliability, and accuracy of your PQube 3.

Still need help? Contact us at support@powerstandards.com.

5 PQube 3 Operation

5.1 User Controls

5.1.1 Navigating the Touchscreen Display

Use the touchscreen on your PQube 3 to navigate the display. You can view live meters, recent events, system information, and perform actions like ejecting removable media and rebooting the unit.

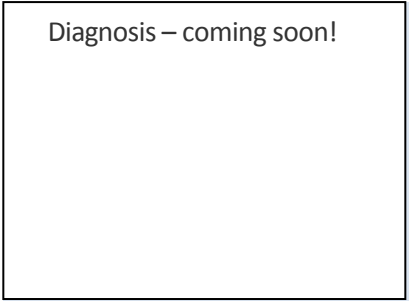
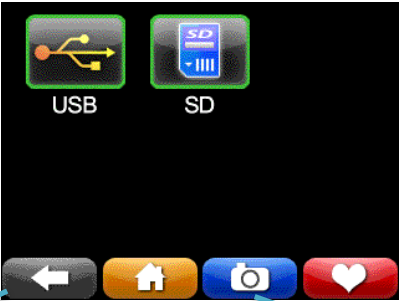
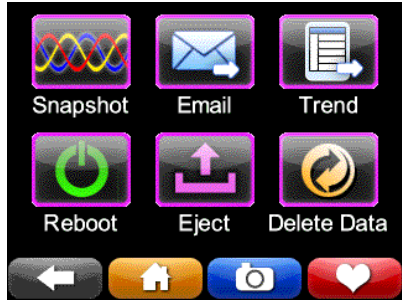

Use the Back button on to go back up one level.

Use the Home button (2nd to left) to go directly to the main screen.

You can save screenshots if you have a USB drive plugged in.

5.1.1.1 System



Date/time: You can change the time and day unless you are configured to synchronize on SNTP or NTP, or your PQube 3 is connected to GPS.

Your PQube 3 will automatically set the correct day of week.



If you have enabled SNTP or NTP in your **Setup.ini** file, your PQube 3 will synchronize to UTC time, then it applies the offset from UTC as specified in your Setup file so that all measurements are time tagged with local time (in this example Pacific Time PST).

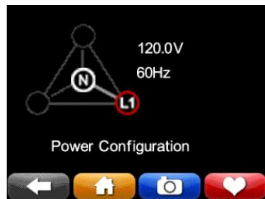

Power configuration: This screen shows you the power configuration, nominal voltage, and nominal frequency that your PQube is using.



Information: Look up your PQube 3's firmware version, model number, serial number. Status is for internal factory use only.



Language: Select the language for the user interface on your screen. By default the language is English-US.

NOTE: If you get a "Fonts missing" message, re-install your language pack by copying the Languages folder onto a USB drive or microSD card and plugging it into your PQube 3.

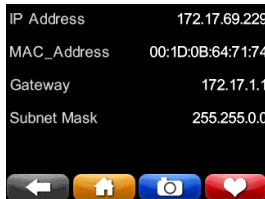

Network: Your PQube 3's IP address and MAC address can be found on this screen. This is useful if you have a dynamic IP address. It is also useful for troubleshooting connectivity issues.



Advanced: UPS battery status and GPS synchronization status are available here. Coming soon! You will be able to view status of your signal relay(s) and your PM2's 24V auxiliary outputs.

5.1.1.2 Meters



Voltage and Frequency: These are line-to-line, line-to-neutral, and neutral-to-earth true-RMS voltmeters. Different meters will show on these screens, depending on your power configuration. (For example, if the power configuration is “delta”, there will not be any L-N meters, because there is no neutral conductor.) If you have set a potential transformer ratio in your **Setup.ini** file, the values will reflect this ratio.



Current: These meters show the true-RMS current. If you have set a current transformer ratio in your **Setup.ini** file, then these meters will use that ratio, so these meters will sometimes show their values in kilo-amps or even mega-amps. Different meters will show on this screen, depending on your power configuration. (For example, if the power configuration is “delta”, this screen will not show a neutral current meter, because there is no neutral conductor in delta power.)

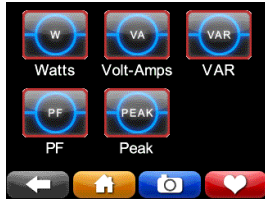

Power: These are the true power, apparent power, and reactive power readings, and they correctly handle harmonics (distorted voltages and distorted currents). If you have set a current transformer ratio and/or potential transformer ratio in your **Setup.ini** file, then these meters will reflect those ratios.

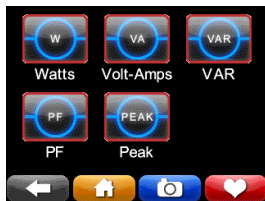
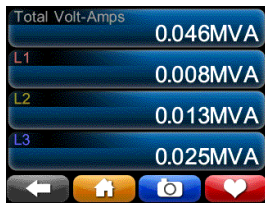

Peaks : These meters show the peak values on Load , Watts and VARS reached . The Peak accumulators can be reset by pressing the Reset button 

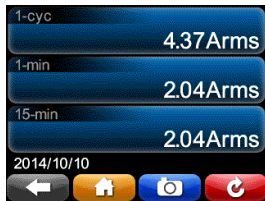



Energy: These three meters show the total energy, apparent energy, and reactive energy.

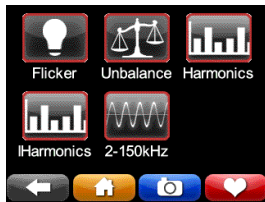
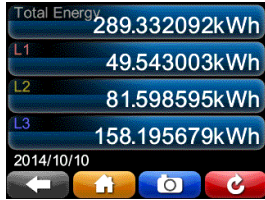

Class A: You will find additional power quality parameters as defined in IEC 61000-4-30 Class A, the international standard for power quality measurement methods.

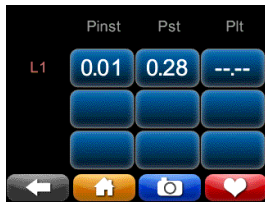

Flicker: These meters show flicker according to IEC 61000-4-15 Edition 2 methods. P_{inst} is the instantaneous flicker value for Incandescent Flicker. P_{ST} is the short term flicker, a statistical analysis of P_{inst} after 10 minutes, synchronized to real-time clock. P_{LT} is the mean value of P_{inst} over previous 2 hours, synchronized to real-time clock.



Unbalance: These meters show the voltage unbalance and the current unbalance. You choose in your **Setup.ini** file whether your PQube calculates unbalance using the ANSI C84.1 method, or the IEC method, or the GB method.

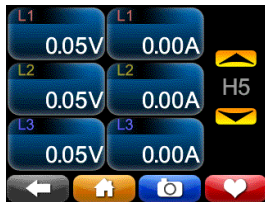

Harmonics: Use this screen to view every harmonic up to the 50th for both voltage and current. Select one harmonic at a time. The selected harmonic applies to all channels. (Harmonic values up to the 63rd are recorded in your PQube 3's CSV files.)

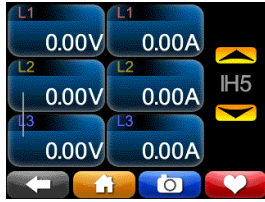

Interharmonics: Use this screen to view every interharmonic up to the 50th for both voltage and current. Select one harmonic at a time. The selected interharmonic applies to all channels. (Harmonic values up to the 63rd are recorded in your PQube 3's CSV files.)

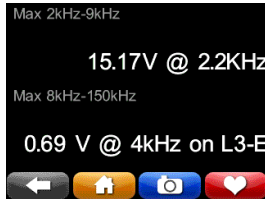

2-150kHz: Use this screen to view the conducted emissions in the 2-150kHz range. Useful for monitoring noise due to interference sources including solar inverters.



More Meters: Additional meters can be found here.



Analog Channels: The Analog meters show the RMS voltage (equivalent to DC voltage for DC signals). You can view the Analog-to-Earth channels (common mode) and the Analog-to-Analog channels (differential mode).

The internal pull-up voltage is 2.5V floating. It will zero out once you connect something to these terminals.



Environmental Meters: If you have ENV2 environmental probes, you can view your temperature, humidity, barometric pressure, acceleration, thermocouple input, and solar irradiance input here.

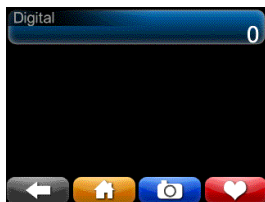

Digital Input: The DIG1 meter shows the average value of the DIG1 digital input averaged over one cycle – useful when the DIG1 signal is changing rapidly, because it will show the duty cycle of the DIG1 signal.

These terminals are wetted at 2.2VDC with a threshold of 1.5V.

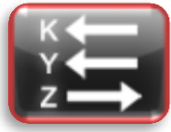

KYZ Pulse Output: Coming soon! Use for revenue-grade energy applications.

5.1.1.3 Recent Events

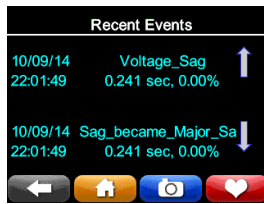

Your PQube displays the 10 most recent events. For each event, you get date/time, event type, and magnitude/duration if applicable. Use the up/down arrows to navigate the list.

5.1.1.4 Actions

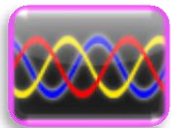

Snapshot: You can trigger a Snapshot (waveform capture) event at any time using this button.



Email: Press this button to send a test e-mail.



Trend: Trigger a partial daily trend for today. The data will begin at midnight and end at the time you pressed the button.



Reboot: Use this button to initiate a soft reboot. A confirmation message will appear, choose YES to reboot.



Eject: Use this button to safely remove any flash media (USB or microSD) that you have plugged into your PQube 3.



Clear: Use this button to clear all events and trends from your PQube 3.

5.1.1.5 Save Files



USB: Use this button to save your recorded data to the USB drive. For now you are able to copy all of the data to the drive, but in a future update you will be able to choose data only from today, this week, or this month as well.



SD: Coming soon! You will be able to use this button to copy data to the removable microSD card in a future firmware update.

5.1.2 Rebooting Your PQube 3

5.1.2.1 To perform a software reboot

You can do a software reboot your PQube 3 using two methods:

1. Touchscreen – From main menu, go to Actions, then Reboot.

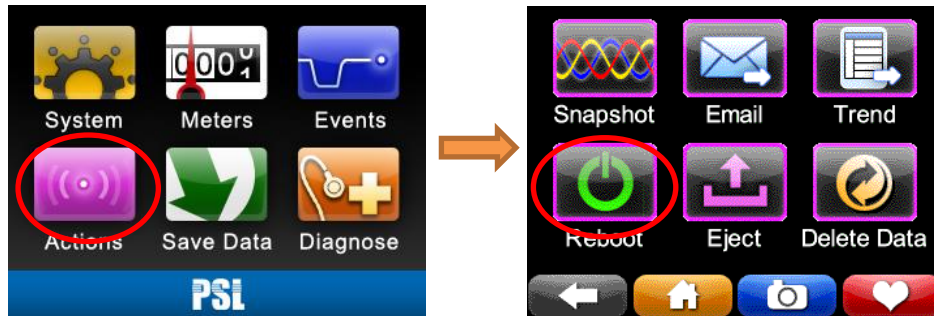

2. Web server – Commands page

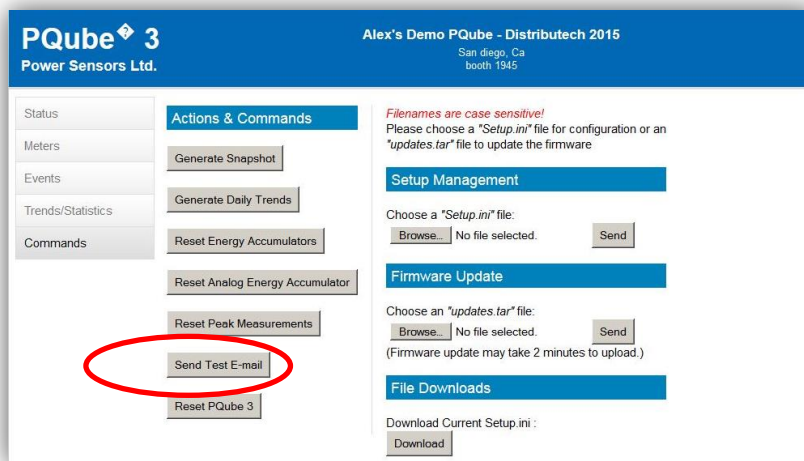

5.1.2.2 To perform a hardware reboot

If you cannot perform a software reboot, press the reset button near the microSD card slot with a paperclip.

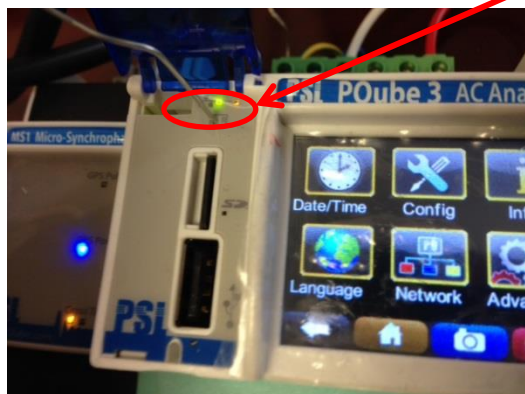

5.1.3 Ejecting your USB thumb drive or microSD card

You can insert a USB thumb drive or microSD card into your PQube 3. Your PQube 3 will automatically detect it.

To remove the USB drive or microSD card, go to the Actions screen and press the Eject button. After the progress bar is complete, you can remove the drive from your PQube 3.

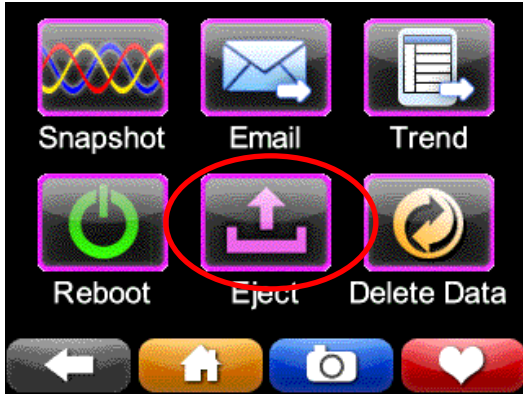

5.2 Accessing the FTP Server on Your PQube 3

Your PQube 3 has a built-in plain FTP server which you can access using any standard FTP client.

There are 5 different FTP accounts available.

1. **ftp_user_1, ftp_user_2, ftp_user_3**
Use these accounts to access events, trends, and logs.
2. **ftp_config**
Use this account to upload a new setup file. After the upload is complete, your PQube 3 will automatically reboot and load your new settings. You can also retrieve your PQube 3's existing setup file using this account.
3. **ftp_updater**
You can upload new firmware to your PQube 3 using this account. After the upload is complete, your PQube 3 will automatically reboot and install the new firmware.

By default, each FTP account is disabled. To enable access for a particular account, you will need to specify a password for that account.

In the PQube 3 Configurator program, go to the Network Setup tab and locate the FTP Profiles section.

Select the FTP account you would like to use, and hit the Enable button. Specify a password (at least 8 characters long) and save your Setup file. After uploading your setup file, that FTP account will be available for you to use.

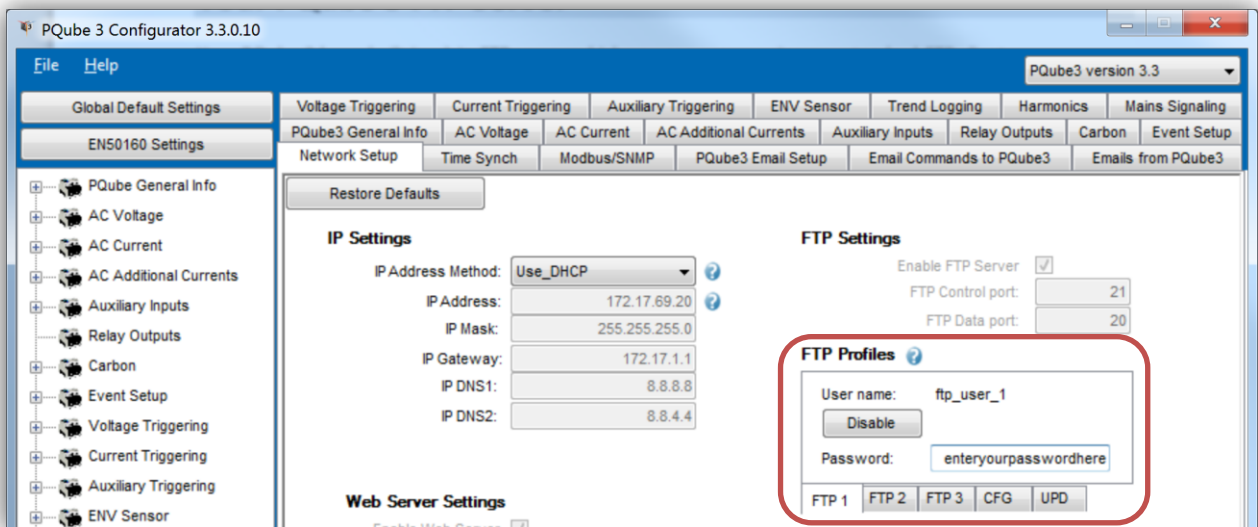

5.3 Accessing the HTTP Web Server on Your PQube 3

To access the web server on your PQube 3, it must be:

- Connected to a network
- Have a valid IP address assigned to it (assigned by DHCP or fixed IP)

To access your PQube 3 online, enter the IP address of the PQube 3 into your Internet Browser.

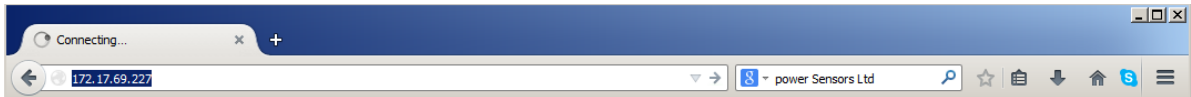

Your browser will automatically direct you to the main Status page.

PQube[®] 3
Power Sensors Ltd.

Alex's Demo PQube - Distributech 2015
San diego, Ca
booth 1945

Status
Meters
Events
Trends/Statistics
Commands

PQube 3 Information

<i>Location:</i>	Distributech 2015
<i>PQube 3 ID:</i>	Alex's Demo PQube
<i>Note 1:</i>	San diego, Ca
<i>Note 2:</i>	booth 1945
<i>PQube 3 Serial Number:</i>	P3001354
<i>Model Number:</i>	PQube3-PQ-E08N-0000
<i>Firmware Version:</i>	3.2.10.15.2.20
<i>IP Address:</i>	172.17.4.25

Configuration

<i>Power Configuration:</i>	Single Phase L1-N
<i>Nominal Line-to-Neutral Voltage:</i>	120V
<i>Nominal Frequency:</i>	60Hz
<i>Potential Transformer Ratio:</i>	1:1
<i>Current Transformer Ratio:</i>	5:0.333

PQube 3 Time

Time: Tue Feb 24 16:42:52 PST 2015

Data from the PSL PQube[®] 3 by www.PowerSensorsLtd.com

5.3.1 Status

The screenshot displays the 'Status' page of a PQube 3 device, organized into three main sections: 'PQube 3 Information', 'Configuration', and 'PQube 3 Time'. Callout boxes with arrows point to specific fields, providing context for their values.

PQube 3 Information	
<i>Location:</i>	Distributech 2015
<i>PQube 3 ID:</i>	Alex's Demo PQube
<i>Note 1:</i>	San diego, Ca
<i>Note 2:</i>	booth 1945
<i>PQube 3 Serial Number:</i>	P3001354
<i>Model Number:</i>	PQube3-PQ-E08N-0000
<i>Firmware Version:</i>	3.2.10.15.2.20
<i>IP Address:</i>	172.17.4.25

Configuration	
<i>Power Configuration:</i>	Single Phase L1-N
<i>Nominal Line-to-Neutral Voltage:</i>	120V
<i>Nominal Frequency:</i>	60Hz
<i>Potential Transformer Ratio:</i>	1:1
<i>Current Transformer Ratio:</i>	5:0.333

PQube 3 Time	
<i>Time:</i>	Tue Feb 24 16:42:52 PST 2015

Data from the PSL PQube® 3 by www.PowerSensorsLtd.com

Callout Boxes:

- PQube Location name & PQube ID as specified in your Setup file:** Points to 'Distributech 2015' and 'Alex's Demo PQube'.
- Note 1 and Note 2 from your Setup file:** Points to 'San diego, Ca' and 'booth 1945'.
- PQube 3 serial number and model number:** Points to 'P3001354' and 'PQube3-PQ-E08N-0000'.
- PQube3 IP address:** Points to '172.17.4.25'.
- Power configuration, nominal voltage, & nominal frequency:** Points to 'Single Phase L1-N', '120V', and '60Hz'.
- Transformer ratios:** Points to '1:1' and '5:0.333'.
- PQube3 date and time (automatically refreshes every few seconds):** Points to 'Tue Feb 24 16:42:52 PST 2015'.

5.3.2 Meters

The page displays and refreshes regularly the various meters. The meters list depends on the power configurations, channels set to be recorded and environment probes connected. You can manually refresh the meters at any time by pressing the refresh button.



PQube® 3
Alex's Demo PQube - Distributech 2015
San Diego, Ca
booth 1945

Status
Meters
Events
Trends/Statistics
Commands

Meters

Meter	Value
L1-N	123.4V
N-E	0.81V
DCIN 1	2.50V
AMPS IN1	2.50A
DCIN 2	2.50V
AMPS IN 2	2.50A
L1 Amp	0.00A
N Amp	0.000A
E Amp	0.000A
Frequency	59.996Hz

ClassA

Meter	Value	
L1 Flicker	P_{inst}	1.14
	P_{ST}	1.28
	P_{LT}	4.26
Max 2kHz-9kHz	0.09V@2000Hz	
Max 8kHz-150kHz	0.62 V @ 2kHz on L1-E	

Probe_1

External Probes	Value
Temperature	24.7deg C
Humidity	29.6% RH
Pressure	1023.123HPA

Internal Sensors

Meter	Value
Battery Current	-0.01 A
Battery Voltage	7.34 V
Battery Temperature	35.8 C
Battery Gauge	99.1 %

Energy

Meter	Value	
AN1XAN2 Power	6.25W	
AN3XAN4 Power	6.24W	
Analog Energy(AN1AN2) <small>(since 2015/02/13)</small>	0.098kWh	
Analog Energy(AN3AN4) <small>(since 2015/02/13)</small>	0.098kWh	
Power	Total	0.000kW
	L1	0.000kW
Apparent Power	Total	0.017kVA
	L1	0.000kVA
True Power Factor	Total	0.00
	L1	0.00
Reactive Power	0.017kVAR	
Energy <small>(since 2015/02/13)</small>	2.107499kWh	
Apparent Energy <small>(since 2015/02/13)</small>	2.107kVAh	
Reactive Energy <small>(since 2015/02/13)</small>	0.000kVARh	
Peak RMS Current <small>(since 2015/02/13)</small>	1 cycle	3.74Arms
	1 minute	3.61Arms
	15 minute	3.48Arms
Peak Power <small>(since 2015/02/13)</small>	1 cycle	0.447kW
	1 minute	0.432kW
	15 minute	0.418kW
Peak Apparent Power <small>(since 2015/02/13)</small>	1 cycle	0.466kVA
	1 minute	0.451kVA
	15 minute	0.437kVA

Data from the PSL PQube® 3 by www.PowerSensorsLtd.com

5.3.3 Events

The page displays the list of events organized around years, and months. Clicking the links provides access to more details down the data files and graphs for each of the events. You can refresh the events listing at any time by pressing the refresh button.

PQube[®] 3
Power Sensors Ltd.

PQUBE3_Stephane_DO - SDO office@PSL
this is a place holder for a very very lengthy note
No parentheses-%/

Status

Meters

Events

Trends and Statistics

Command

2014 PQube 3 Events		
Month	Events	Files
2014/09	66	File List
2014/08	159	File List
2014/07	536	File List
2014/06	108	File List

Links to the details of the events for a given month.

2014/09 PQube 3 Events					
Date	Time	Type	Magnitude	Duration in Seconds	Files
2014/09/17	T 01:45:34:570 PDT	RVC	5.87%	0.041	File List
2014/09/17	T 01:45:34:553 PDT	Waveshape_Change	0.00%	N/A	File List
2014/09/17	T 00:00:16:408 PDT	Snapshot	0.00%	N/A	File List
2014/09/15	T 17:51:42:620 PDT	Voltage_Sag	0.58%	0.509	File List
2014/09/15	T 17:51:42:637 PDT	Interruption	0.58%	0.483	File List
2014/09/15	T 08:58:28:653 PDT	Probe_1_Overttemperature	48.77deg C	14288.000	File List
2014/09/15	T 00:00:28:231 PDT	Snapshot	0.00%	N/A	File List
2014/09/14	T 00:00:23:572 PDT	Snapshot	0.00%	N/A	File List
2014/09/13	T 16:34:28:191 PDT	Waveshape_Change	0.00%	N/A	File List
2014/09/13	T 05:58:55:500 PDT	Waveshape_Change	0.00%	N/A	File List
2014/09/13	T 05:58:55:125 PDT	Voltage_Sag	79.96%	0.017	File List
2014/09/13	T 05:58:55:108 PDT	Waveshape_Change	0.00%	N/A	File List
2014/09/13	T 02:14:45:882 PDT	RVC	9.32%	1.267	File List

Links to the data files and waveform and RMS graphs for each event

Distributech 2015 2015/02/24 (T 17:15:26.445 PST) Voltage_Sag			
Graphs	PQDIF	Spreadsheets	Summaries
P3001354_2015-02-24_T_17-15-26-445_Voltage_Sag_RMS.gif	P3001354_2015-02-24_T_17-15-26-445_Voltage_Sag_PQDIF.pod	P3001354_2015-02-24_T_17-15-26-445_Voltage_Sag_RMS.csv	P3001354_Event.htm
P3001354_2015-02-24_T_17-15-26-445_Voltage_Sag_Waveform.gif		P3001354_2015-02-24_T_17-15-26-445_Voltage_Sag_Waveform_Beg.csv	P3001354_Event.txt
		P3001354_2015-02-24_T_17-15-26-445_Voltage_Sag_Waveform_End.csv	P3001354_Event.xml

5.3.4 Trends

You can refresh the trends listing at any time by pressing the refresh button.

PQube® 3
Power Sensors Ltd.

Alex's Demo PQube - Distributech 2015
San diego, Ca
booth 1945

Month	Trends/Statistics	Files
2015/02	23	File List
2015 Weekly	3	File List

Links to daily/weekly/monthly trend files

Type	Date	Files
Daily	2015/02/23 (Monday)	File List
Daily	2015/02/22 (Sunday)	File List
Daily	2015/02/21 (Saturday)	File List
Daily	2015/02/20 (Friday)	File List
Daily	2015/02/19 (Thursday)	File List
Daily	2015/02/18 (Wednesday)	File List
Daily	2015/02/17 (Tuesday)	File List

Clicking on "File List" brings the list of daily trends for each day

Clicking on "File List" brings the daily trend files

Distributech 2015 Daily Trends and Statistics			
Graphs	PQDIF	Spreadsheets	Summaries
P3001354 2015-02-23 Daily AN-Digital Trends.gif P3001354 2015-02-23 Daily Flicker Trends.gif P3001354 2015-02-23 Daily Individual Current Trends.gif P3001354 2015-02-23 Daily Individual Power Trends.gif P3001354 2015-02-23 Daily L-N Voltage Trends.gif P3001354 2015-02-23 Daily Power Trends.gif P3001354 2015-02-23 Daily THD-Unbalance Trends.gif P3001354 2015-02-23 Daily Temperature-Humidity Trends.gif P3001354 2015-02-23 Daily Voltage-Current Trends.gif	P3001354 2015-02-23 Trends-Stats PQDIF.pod	P3001354 2015-02-23 Statistics.csv P3001354 2015-02-23 Trends.csv	P3001354 TrendStat.htm P3001354 TrendStat.txt P3001354 TrendStat.xml

5.3.5 Commands

From the Commands page, you can trigger snapshots or daily trends, send test emails, or reset your PQube 3. You can also apply new setup files and firmware updates from here.

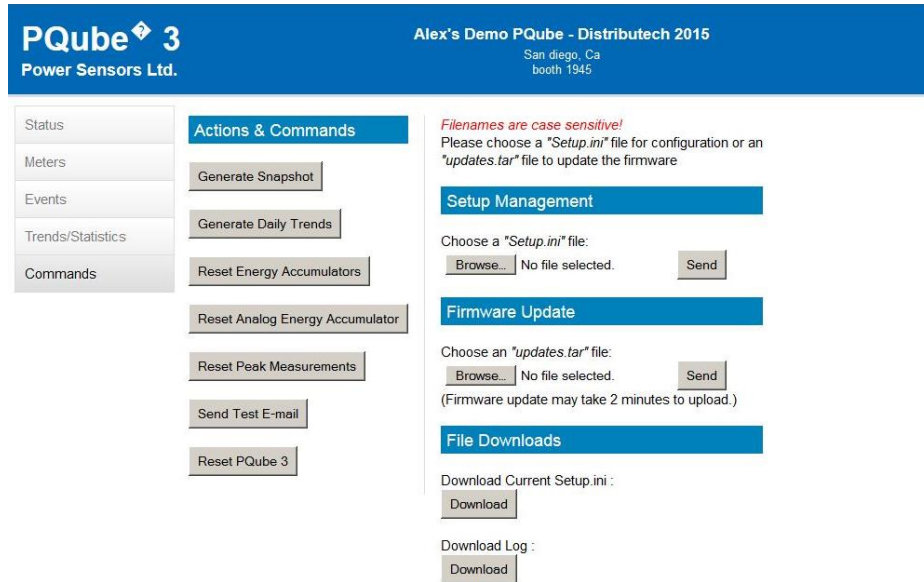

You can restrict access to this page by specifying a username and password for the HTTP Administrator in your setup file.

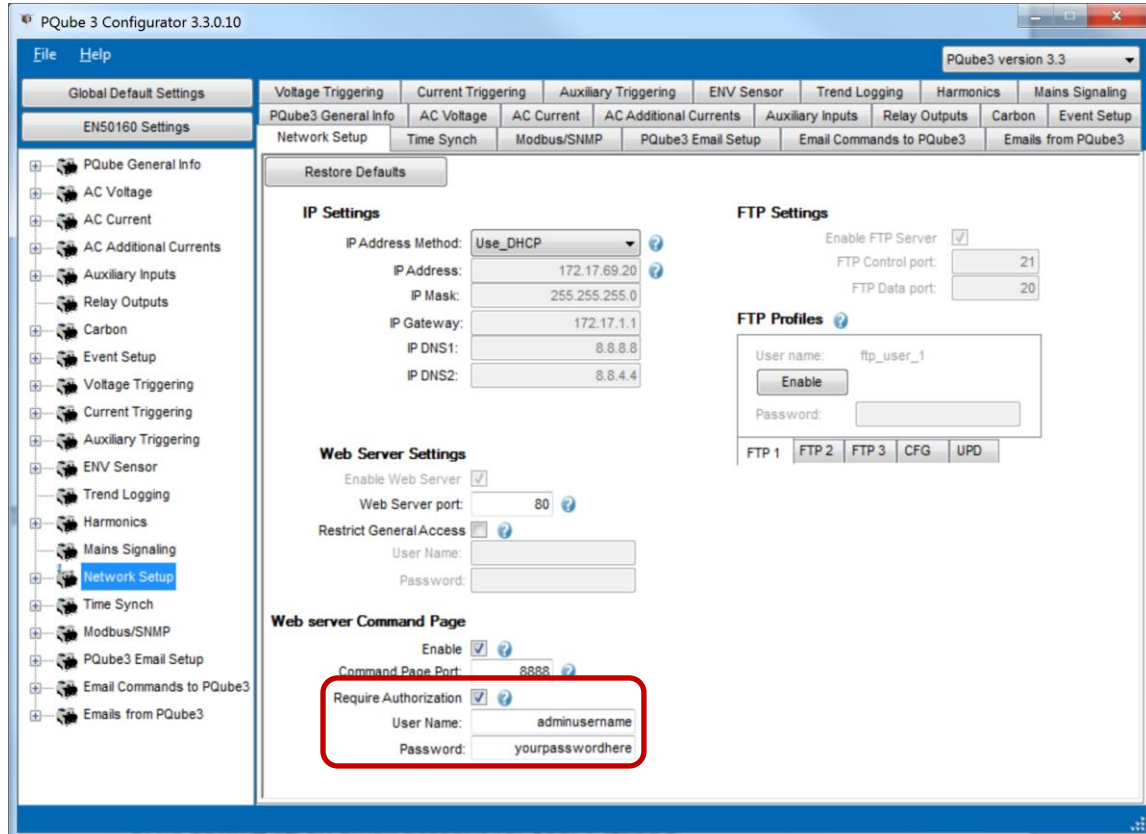

5.4 PQube 3 Email Setup

You can configure your PQube 3 to send you an email whenever new data is available, or if there is any system activity. You can also execute commands on your PQube 3 by sending emails with the command name in the subject line. All you need to do is provide a dedicated email account for your PQube 3, and define a list of email recipients.

5.4.1 Setting up an email account for your PQube 3

Your PQube 3 needs its own email account. All emails from your PQube will be sent from this email address, and all email commands from you will be sent to this email address.

PSL provides a free email account for every PQube 3. Use the PQube 3 Configurator to automatically set up the pqube.com email account for your PQube 3.

If you don't want to use your free pqube.com email account, our PQube 3 supports accounts from common email providers such as Yahoo! and Google. At this time, Microsoft Exchange Server is not supported.

If you want to use an email account using your own company's domain, go to the PQube3 Email Setup section of your Setup file and enter the following information below. You will need to obtain this information from your IT or System Administrator.

Please tell your System Administrator that:

- Your PQube 3 is a standard e-mail client.
- For outgoing mail, your PQube supports plain-text authentication, SSL, Cram-MD5, or MD5-Digest login protocols.
- For incoming mail, your PQube supports plain-text authentication, SSL, Cram-MD5, MD5-Digest, USER-PASS, or APOP login protocols.
- Ask your System Administrator to set up an e-mail account, and get the following information from them:

SMTP Server: _____ Port: _____ Auth method: _____

POP Server: _____ Port: _____ Auth method: _____

PQube e-mail address: _____

PQube e-mail user name: _____

PQube e-mail password: _____

- Use this information to fill in your **Setup.ini** file in the PQube3 Email Setup tab.

WARNING

Do not assign your personal email address to your PQube 3. Your PQube 3 must have its own dedicated email address that it can use to send and receive email. Power Sensors Ltd. is not responsible for any loss of data.

5.4.2 Getting event notifications and trend data from your PQube 3 by email

To begin with, choose what type of data you would like to receive from your PQube 3. You can choose Event data, Trend data, Reset emails, or all email types. If applicable, your PQube 3 will include output files as attachments.

You need to specify who will be receiving these emails. You can specify up to five Email_To recipients, five Email_CC_To recipients, and five Email_BCC_To recipients.

For events, you can also set up to nine total recipients for event summary emails. This is useful for people who only need quick notifications that an event occurred, without requiring detailed waveforms and graphs.

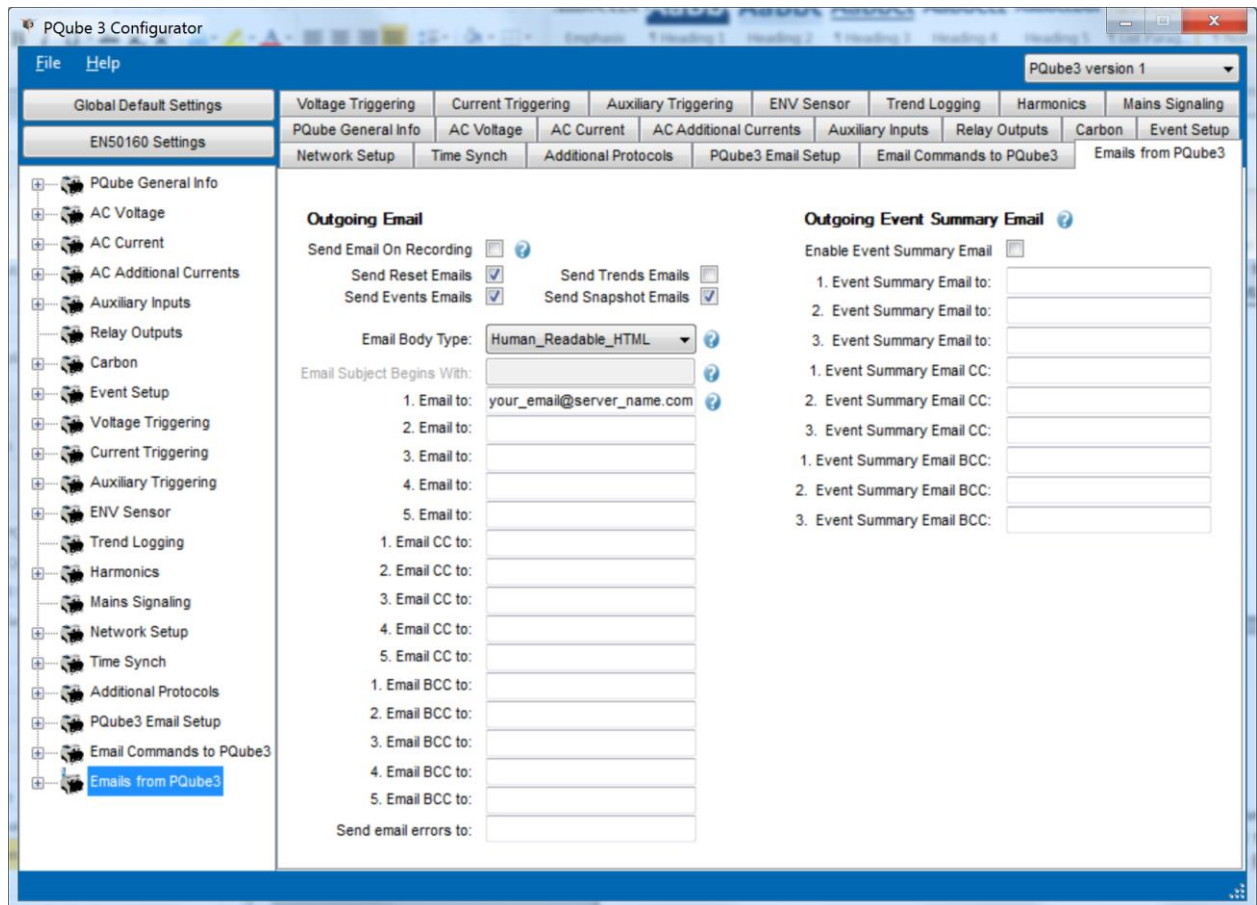

5.4.3 Sending commands to your PQube 3 over email

To begin with, enable Incoming Emails [to your PQube 3] by checking the box labeled Incoming Emails at the Email Commands to PQube 3 tab. Your PQube 3 will log into its email account at regular intervals. You can set this interval (in seconds) at this section.

For security reasons, you may want to specify a subject keyword and add names to the email whitelist. For an email command to be successfully processed, the email command must be sent from someone on the email whitelist, and the first word in the subject must begin with this subject keyword. Set the subject keyword and email whitelist in the Incoming Email Filter section.

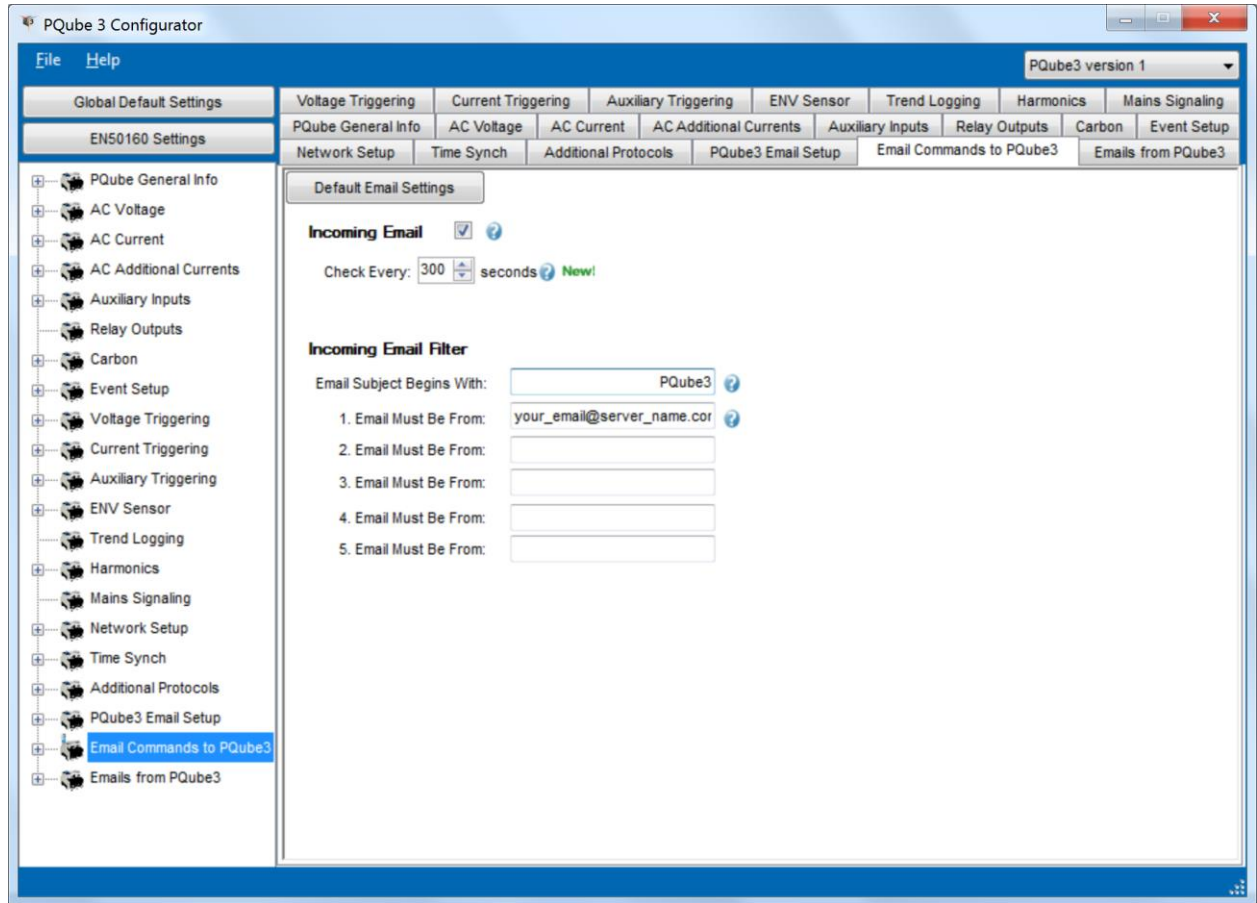

5.4.3.1 List of Email Commands

Command (case sensitive)	Description
New Setup File	Your new setup file must be named Setup.ini , and must be attached to the e-mail. Your PQube 3 will send you two reply e-mails: one when it receives the new setup file, and another when the new setup file has been successfully installed.
Firmware Update	Obtain a firmware update from www.PowerStandards.com and attach it to the email. If your PQube 3 receives a valid firmware update, it will reset and perform the update.
Reset PQube	Resets PQube 3 upon receipt of email. This is useful when loading a new setup file or firmware via FTP.
Send Logs	You can ask your PQube 3 to send you its log files via e-mail. The log files can help diagnose PQube setup problems, and they show the complete history of your PQube. For faster technical support, please include these files when contacting our technical support department.
Send Setup	Retrieve the existing setup file from your PQube 3.
Generate Snapshot	Takes a waveform recording of your power.
Generate Daily Trends	Generates the Daily Trends for today. The data ranges from Midnight to the moment the email request is received.
Reset Energy Accumulators	Resets all accumulated energy values.
Reset Peak Measurements	Resets all peak values for the Peak Amps, Peak Demand, and Peak VA meters.
Reset Analog Energy Accumulator*	Resets accumulated Analog energy values.
Set Harmonic of Interest to #*	Sets the Harmonic of Interest on the PQube display and Web Server. Replace # with the desired harmonic order of interest (1-50).

* = coming soon

5.5 Modbus Setup

5.5.1 Basics

Your PQube 3 has a built-in Modbus-over-TCP server that you can use to read meters and determine when new event or trend recordings are available.

You can set the following parameters in your PQube 3's setup.ini file:

Modbus Base Address: The global base address from which all registers are offset. Default is 0x7000.

Modbus Query Port: The TCP/IP port on which the Modbus server listens. Default is port 502.

Modbus Byte Order: Data values spanning multiple registers (such as floats) can be reported in BIG ENDIAN or LITTLE ENDIAN. Default is BIG_ENDIAN.

Modbus Slave ID: The PQube can be assigned a slave ID required in queries. Default value is 0x1.

5.5.2 Scan rates, client load, and limitations

The Modbus protocol limits single query register results to 125 registers per scan. A scan of sets of registers can occur at client, PQube, and network speeds. **However, the PQube3 modbus register values only update at the internal meter update rate, which is around 2 Hz.** Therefore, high rate scans of values in sets of registers will only change returned at 2 Hz, even if scanning at higher rates is supported.

The PQube supports multi-client, multi-session modbus, with conventional limit to 10 clients at a time. This value can be changed internally in software.

5.5.3 Supported Clients

The PQube3 supports the **PSL Modbus Client**, third party free Modbus clients, or any software conforming to the Modbus protocol (such as groov).

5.5.4 Register List (refer to Modbus Reference Manual)

Refer to the **PQube 3 Modbus Reference Manual** for the register tables.

5.5.5 Downloads

The **PSL Modbus Client** and **PQube 3 Modbus Reference Manual** are available for download at:

http://www.powersensorsltd.com/PQube3_Reg.php

5.6 LED Definitions

5.6.1 PQube 3

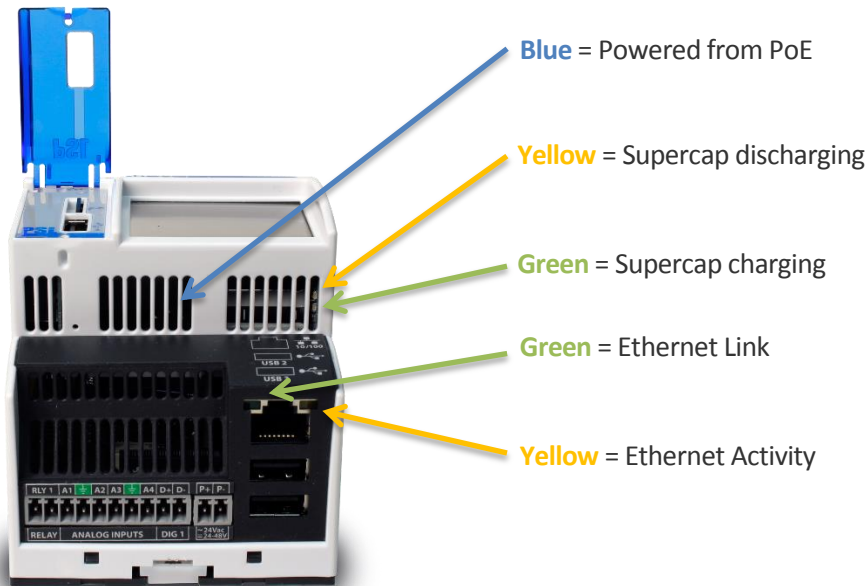
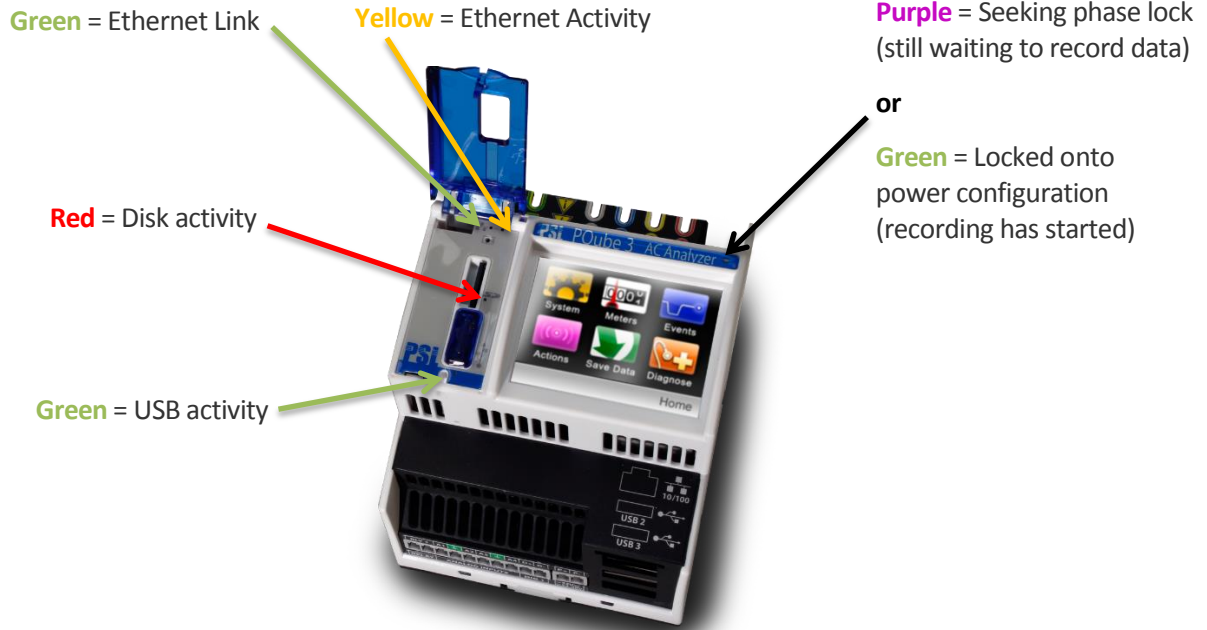

5.6.2 MS1

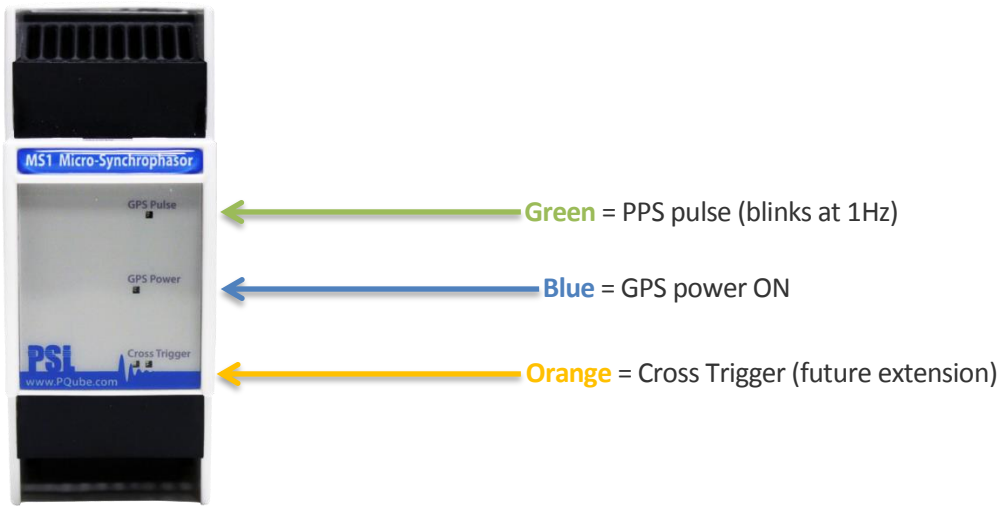

5.6.3 PM1/PM2

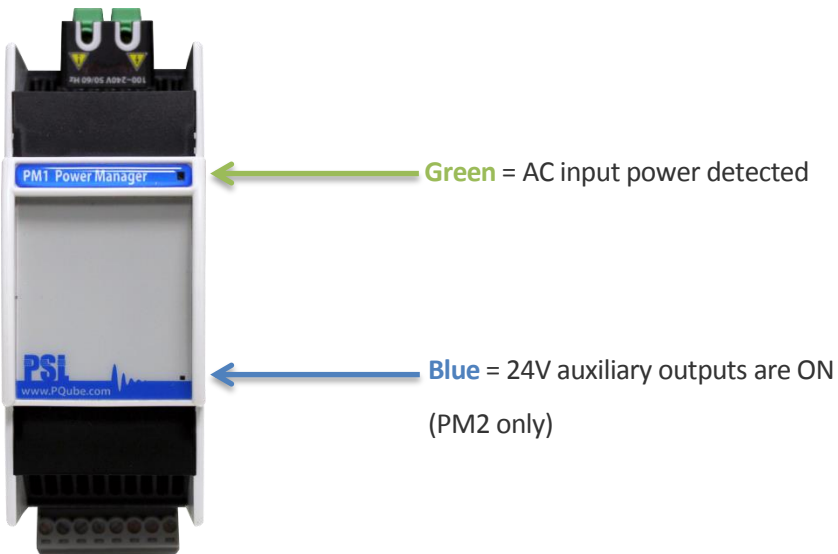

5.6.4 UPS1

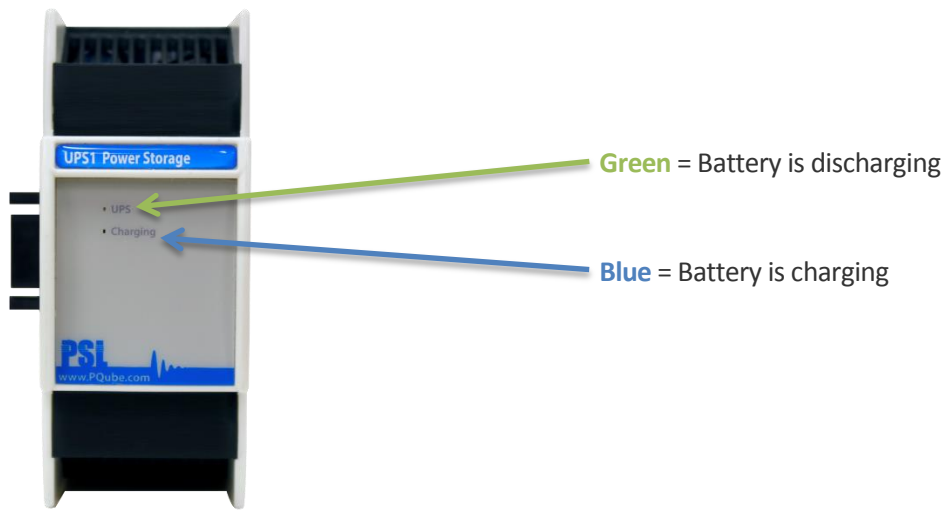

5.6.5 ENV1/ENV2

Green blinking at 1Hz = Normal operation
Green blinking at 2Hz = Acceleration event in progress (ENV2 only)
Red blinking = Powered, but not communicating with PQube 3
Red solid = Transmitting event data to PQube 3



5.7 Upgrading the Firmware on your PQube 3

The process to perform firmware updates is similar to applying new setup files.

5.7.1.1 To apply firmware updates locally

Copy updates.tar onto a USB thumb drive or microSD card, then insert it into your PQube 3. The update process will begin automatically and the device will restart after several minutes. PSL provides the firmware updates as compressed tar files. Make sure the file name is updates.tar when you copy it to your flash drive.

After successful update and reboot, your PQube 3 automatically renames updates.tar to updatesYYYYMMDDHHMMSS.tar so it does not repeatedly initiate the firmware update process. Look at the filename to verify that your PQube 3 successfully processed the firmware update.

5.7.1.2 To apply firmware updates over the web

You can also update the firmware through the Web page <Command> by selecting the file with the [browse] button, and then pressing [send]. Although the browser states that the file is sent, it may take up to 15 minutes for the PQube 3 to update its firmware and reboot, depending on the firmware file size and network connection speeds.

The screenshot shows the PQube 3 web interface. At the top, there is a blue header with the PQube 3 logo and 'Power Sensors Ltd.' on the left, and 'Alex's Demo PQube - Distributech 2015' with 'San diego, Ca booth 1945' on the right. Below the header is a navigation menu with 'Status', 'Meters', 'Events', 'Trends/Statistics', and 'Commands'. The 'Commands' section is active, showing a list of actions: 'Generate Snapshot', 'Generate Daily Trends', 'Reset Energy Accumulators', 'Reset Analog Energy Accumulator', 'Reset Peak Measurements', 'Send Test E-mail', and 'Reset PQube 3'. To the right of the actions is a 'Firmware Update' section. It contains a warning: 'Filename are case sensitive! Please choose a "Setup.ini" file for configuration or an "updates.tar" file to update the firmware'. Below this are two sections: 'Setup Management' and 'Firmware Update'. The 'Setup Management' section has a 'Choose a "Setup.ini" file:' label, a 'Browse...' button, 'No file selected.', and a 'Send' button. The 'Firmware Update' section has a 'Choose an "updates.tar" file:' label, a 'Browse...' button, 'No file selected.', and a 'Send' button. Below these is a 'File Downloads' section with two 'Download' buttons: 'Download Current Setup.ini :' and 'Download Log :'. The 'Send' buttons are currently disabled.

Web page for sending a configuration or updating the firmware

5.7.1.3 Applying a firmware update over email

If you have Incoming Email enabled on your PQube 3, you can attach updates.tar to an email and your PQube will download and process the file automatically.

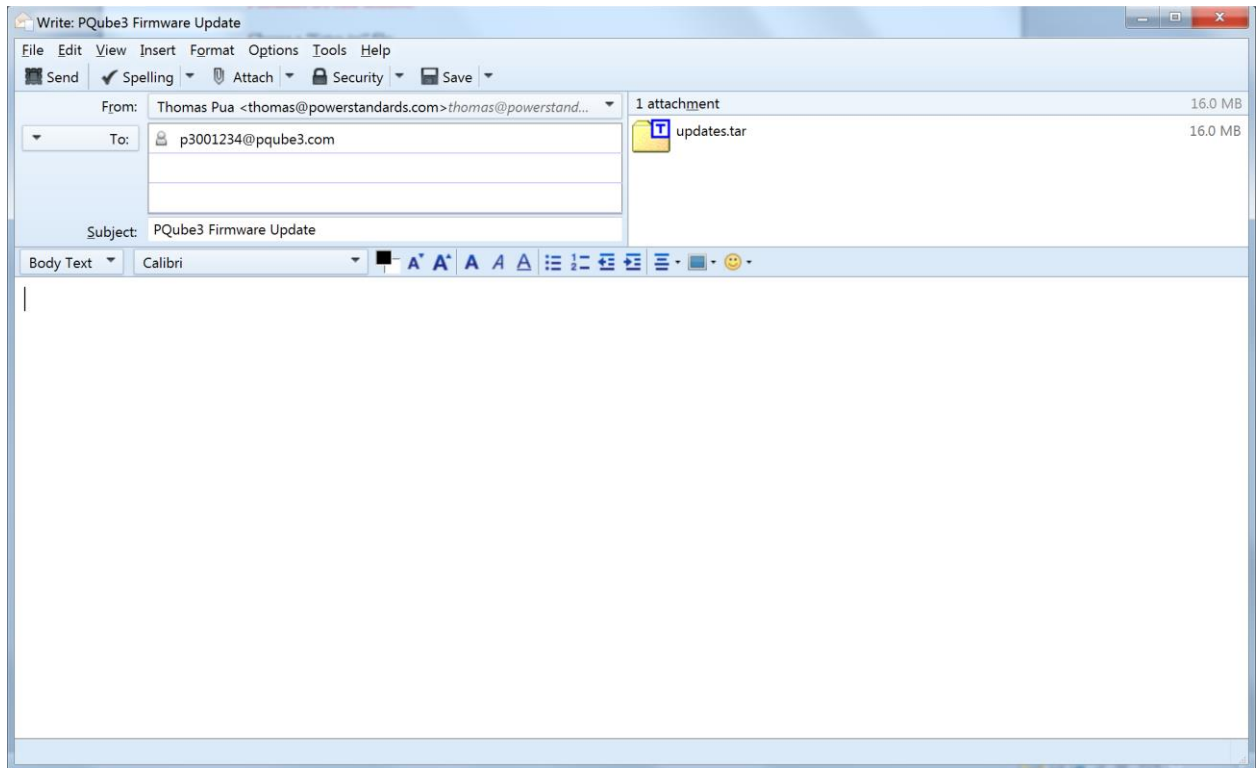

5.7.1.4 Apply a firmware update over FTP

Log into your PQube 3's FTP server with the username **ftp_updater**. Upload updates.tar into the folder and your PQube 3 will automatically reboot and apply the update.

For instructions on how to access your PQube 3's FTP server, refer to page [51](#).

5.7.1.5 Be notified when a new firmware update is available

Register at www.pqube3.com and we'll send you an email whenever a new firmware update is available.

If you prefer not to register, you can also periodically check www.pqube3.com for news and updates.

5.8 Maintenance

5.8.1 Turning Off Your PQube 3

Your PQube 3 is designed to be a permanently installed monitor. It does not have an on/off switch because it is designed to run continuously. If you need to turn off your PQube 3, remove your PQube 3's instrument power (either the power screw terminal block on your PQube 3, the optional PM1 Power Supply Module, or PoE). Your PQube 3 will automatically initiate graceful shutdown to prevent any write damage to flash.

If you have a UPS module installed, your PQube 3 will continue to run for the allotted amount of time. To immediately power down the device while on backup power from the UPS module, go to the Actions screen and press Reboot. With no permanent power source available, your PQube 3 will simply turn off.

5.8.2 Replacing Your PQube 3's Clock Battery

Your PQube 3 uses a user-replaceable, non-rechargeable lithium-manganese coin cell battery to back up the system clock in the event of instrument power loss. PSL recommends replacing this battery every 10 years. When you order a replacement battery, always remember to power off the device first, disconnect mains connections, and verify disconnections.



To remove and replace the battery, insert a small flat-head screwdriver to pry up the label near the USB port and microSD card slot. Remove the old battery and install the new one. It is not possible to install the battery with the wrong polarity.

Follow all applicable federal, state, and local regulations when disposing of the used battery.



Disconnect power to the device before replacing the battery.

Replace battery with a PSL-supplied battery only. Use of another battery may present a risk of fire or explosion. This part must be supplied only by PSL or PSL agents.

5.8.3 Life Expectancy of the PQube 3 and the PM1 module

The estimated life expectancy of a PQube 3 and its PM1 module is 8 years (estimation based on operating temperature at 20-30degC).

5.8.4 UPS1 Life Expectancy and Long Term Storage Instructions

The lithium ion batteries in your UPS1 module are rated for 3 years or 500 cycles, whichever comes first. Contact PSL to replace the batteries. Do not attempt to replace the batteries yourself.

If you need to store your PQube 3 and modules on the shelf for 3 months or longer, all you need to do is charge your UPS1 module up to full before putting it away. Simply turn on your PQube 3 with the UPS1 module, and let it run for at least 20 hours to ensure a full charge.

If you will be storing your PQube 3 and modules for more than 1 year, be sure to periodically recharge your UPS1 module at least once per year to avoid full discharge.

5.8.5 Cleaning Instructions

If necessary, wipe the accessible parts of your PQube 3 with a slightly damp cloth while it is powered off. Do not use abrasives or chemical cleaners and do not clean your PQube 3 while it is powered on.

5.8.6 Reasons for reset

If your PQube 3 is configured to email you whenever system activity occurs, it will notify you whenever it has reset.

Reset reasons	Description
System Timeout reached	One of the processes of the PQube is stuck or takes too much time to complete compared to expected
Setup File Sent	A new setup.ini file has been sent
Update Required Restart	A firmware update was sent and PQube3 restarted
User Triggered Display Reboot	The touch screen <Action> <reboot> has been used
Web Command Reboot	A reset has been requested from the web command page
Battery Timeout Reached. Battery Percentage: XX%	The PQube has shut down after reaching the configured autonomy of battery (see PQube configuration).
Unspecified Reason	No reason identified (default)

5.9 Calibration Information for Your PQube 3

Every PQube 3 is calibrated and traced to NIST at the factory. You can download a free NIST trace certificate that contains the specific calibration information for your PQube 3 by entering your PQube 3's serial number at <http://www.powersensorsltd.com/CalibCerts3.php>.

5.10 PQube 3 technical specifications

The **PQube 3 Technical specifications** are available for download at:

<http://www.powersensorsltd.com/PQube3.php>

6 Appendix 1: Setup File Guide

6.1.1 Device Setup

Setup.ini Tags	Comments	Valid Values	Example
[PQube_Information]	General Information about your PQube		
PQube_ID="PSL PQube in PSL Cal Lab"	The unique identifier will appear on all output information. Quotation marks (") are required.	Any combination of letters, numbers, spaces and special characters ['-;', '%', '_'] up to 63 characters	
Location_Name="PSL Calibration Lab" Note_1="PSL PQube – General Demonstrator" Note_2="(Located in PSL Calibration Lab)"	Appears on all Event/Snapshot and Trends and Statistics recordings. Quotation marks (") are required.	Any combination of letters, numbers, spaces and special characters ['-;', '%', '_'] up to 63 characters	
Power_Configuration=AUTO	<p>Set this tag to AUTO if you want your PQube to automatically choose its Power Configuration based on the voltage it finds on its input terminals when it starts up.</p> <p>Alternatively, you can specify exactly which power configuration you would like your PQube to lock onto.</p> <p>Choose AUX to enable data recording using only the auxiliary channels (analog, digital, environmental). No mains AC voltage is required to begin recording.</p>	AUTO Single_Phase_L1_N Single_Phase_L1_L2 Split_Phase Star Wye Delta AUX	

Time_Zone=PST	Enter the time zone where your PQube is located. UTC sometimes called Greenwich Mean Time (GMT)	Any combination of 3 or 4 capital letters	
Offset_From_UTC_In_Hours=	Choose the number of hours your PQube should add or subtract from UTC to calculate your local time, if you are using SNTP protocol to set your PQube's time. For example, the offset from UTC in Pacific Standard Time is -8. Your PQube will automatically apply this offset after synchronizing to an external time source like a time server or GPS receiver.	-24 to +24	
UPS_Time_In_Minutes=	Choose the number of minutes your PQube UPS1 battery autonomy. This allows to program sufficient back up power for several outages in short sequence.. By default the autonomy is 3 minutes.	3 to 30	
Fan_Temperature_Threshold=	Your PQube 3's internal fan turns on when the CPU temperature exceeds this threshold. By default, the temperature threshold for the internal fan is 60.	40-60	
PQube_Primary_Language= PQube_Secondary_Language=	Choose the language amongst a list of 30+ languages. Default is English-American.	Arabic-Standard Cambodian Chinese-Simplified Chinese-Traditional Croatian Czech Danish Dutch	Magyar Malaysian-Bahasa Norwegian Persian Polish Portuguese-Brazil Portuguese-Portugal Romanian Russian

		English-American English-British English-India Finish French-Canada French-France German Greek Hebrew Hindi-Devenagari Indonesian-Bahasa Italian Japanese Korean	Serbian Slovakian Slovenian Spanish-LatinAmerica Spanish-Mexico Spanish-Spain Swedish Tagalog Thai Turkish Ukrainian Vietnamese
[Nominal_Inputs]			
Nominal_Phase_To_Phase_Voltage=AUTO Nominal_Phase_To_Neutral_Voltage=AUTO	By default, your PQube will automatically detect your nominal voltage if it is one of the following: Phase-Neutral 69V, 120V, 230V, 277V, 350V, or 400V Phase-Phase 69V, 100V, 200V, 208V, 240V, 400V, 480V, 600V, or 690V If using Potential Transformers, you will need to enter the actual primary voltage.	AUTO Any number between 50 to 400 for Phase-Neutral Any number between 50 to 690 for Phase-Phase	Nominal_Phase_To_Phase_Voltage= 110 If using a 1000:1 Potential Transformer: Nominal_Phase_To_Phase_Voltage= 110000
Nominal_Frequency=AUTO	By default, your PQube will automatically detect your nominal frequency if it is 50, 60, or 400 Hz.	AUTO 16 (corresponds	

	You can also manually set the frequency to 50, 60, or any frequency between 320 and 560Hz.	to 16.67Hz) 50 60 Any number between 320 to 560	
[Channel_Recordings]			
Generate_GIF_Graphs=ON Generate_PQDIF_Files=ON	Choose the types of files your PQube will generate for events and trends ; ----- Valid Values: ON, OFF		
Recorded_Samples_Per_Cycle=256	; ----- Choose the number of samples/cycle for waveform recordings ; ----- This does not change your PQube 3's sampling rate, only the level of detail in your waveform graphs. Your PQube 3 always samples at 512 samples/cycle. ; ----- Your choice is a tradeoff between graph resolution and the overall number of cycles displayed in the graph. ; ----- Valid Values: 32, 64, 128, 256, 512. Typical value 256 ; ----- There are 4096 total samples in the waveform buffer. Your PQube records 8 cycles at value 512, 16 cycles at value 256, ..., 128 cycles at value 32		
Record_Phase_To_Phase_Channels=AUTO Record_Phase_To_Neutral_Channels=AUTO	If your Power Configuration includes a neutral conductor, your PQube will automatically be set to record Phase-Neutral channels. If your Power Configuration includes multiple phases, it will automatically record Phase-Phase channels in the Meters (on display, webpage, and	AUTO ON OFF	

	Modbus), GIFs, and CSV files.		
Record_Current_I1_I2_I3_Channel=OFF Record_Current_I4_Channel=AUTO Record_Current_I5_Channel=AUTO Record_Current_I6_Channel=OFF Record_Current_I7_Channel=OFF Record_Current_I8_Channel=OFF	New tags in PQube 3. You can choose to show or hide any or all of the 8 current channels.	AUTO ON OFF	
Record_AN1_E_Channel=AUTO Record_AN2_E_Channel=AUTO Record_AN1_AN2_Differential_Channel=AUTO Record_AN3_E_Channel=AUTO Record_AN4_E_Channel=AUTO Record_AN3_AN4_Differential_Channel=AUTO Record_DIG1_Channel=AUTO	The AUTO setting records the Analog and Digital Input channels if Events are enabled on these channels.	AUTO ON OFF	
Record_Flicker=ON Record_Voltage_THD=ON Record_Current_TDD=ON Record_Voltage_Unbalance=ON Record_Current_Unbalance=ON	Toggles recordings for the selected parameters. When set to ON, the selected parameter will show up in the Meters (display, webpage, and Modbus), as well as the GIF and CSV files. You might want to toggle some of these parameters OFF in order to reduce file size and bandwidth.	ON OFF	
[Measurement_Setup]			
Peak_Demand_Interval_In_Minutes=15	; ----- Define peak demand - peak Watt and VA - 1 cycle and min are included ; ----- Valid Values: 3, 5, 10, 15, 20, 30, 60, typical values 10 mins (or 15 in North America)		

KYZ_Relay_in_Wh_per_Pulse=0	Energy output KYZ, expressed in Watt-hour per pulse.	0 (to disable output) Any number	
Record_IEC_61000-4-30_10_Min_Interval=OFF	Enable 10-minute and 2-hour interval trend recordings in a separate CSV file, per the requirements of IEC 61000-4-30 Class A.	ON OFF	
Enable_10_Second_Frequency=OFF	Default setting is OFF. With OFF setting, the frequency measurement interval is 1 second. Set this tag ON to change the frequency interval to 10 seconds, per the methods in IEC 61000-4-30 Class A Clause 5.1	ON OFF	
Record_2-150kHz_Conducted_Emissions=ON	Toggles the 2-150kHz daily trend file generation.	ON OFF	
Current_Range="LOW"	For currents, HIGH range = ±10V peak LOW range = 0.333Vrms	HIGH LOW	
Flicker_Lamp_Voltage=230	Sets the lamp voltage rating for your flicker measurements, per the requirements of IEC 61000-4-15 Ed. 2 Class F1. Your PQube sets the response curve based on the lamp voltage rating and nominal frequency.	120 230	
[Potential_Transformers]	This allows you to express amplitudes measured at the primary of the transformer.		
Potential_Transformer_Ratio=1:1	You can use fractional values such as 1250.5:120. The PT ratio will appear on the display, webpage, and the CSV header. If the PT ratio is high enough, your PQube will automatically switch the units to kV or MV.	From 1:1 to 50000:1	Potential_Transformer_Ratio= 14400:120
[Current_Transformers]	Allows you to express the amplitude of currents measured at the primary of the current		

	transformer.		
<p>Current_Transformer_Ratio=1:1</p> <p>Neutral_Current_Transformer_Ratio=1:1</p> <p>Earth_Current_Transformer_Ratio=1:1</p> <p>Current_I6_Transformer_Ratio=1:1</p> <p>Current_I7_Transformer_Ratio=1:1</p> <p>Current_I8_Transformer_Ratio=1:1</p>	<p>When using PSL CTs with 0.333V secondary rating, the second number is the voltage.</p> <p>You can use fractional values such as 100.35:0.333</p> <p>If the CT ratio is high enough, your PQube will automatically switch the units to kA.</p>	<p>From 1:1 to 50000:1</p>	<p>Current_Transformer_Ratio=5:0.333</p>
[Adjust_Phase_Connections]			
<p>Invert_Current_I1_Channel=OFF</p> <p>Invert_Current_I2_Channel=OFF</p> <p>Invert_Current_I3_Channel=OFF</p> <p>Invert_Current_I4_Channel=OFF</p> <p>Invert_Current_I5_Channel=OFF</p> <p>Invert_Current_I6_Channel=OFF</p> <p>Invert_Current_I7_Channel=OFF</p> <p>Invert_Current_I8_Channel=OFF</p>	<p>Those tags are used to virtually invert cabling of current inputs (swap wires), individually for each input.</p> <p>This can be useful if a wiring mistake has been made during the commissioning.</p>	<p>ON</p> <p>OFF</p>	
[Analog_Channel_Setup]			
<p>AN1xAN2_Energy_Mode=OFF</p> <p>AN3xAN4_Energy_Mode=OFF</p>	<p>Toggle Analog Energy mode.</p> <p>AN1-AN2 differential channel becomes Analog Power (AN1xAN2) and Analog Energy (AN1xAN2xHours).</p> <p>AN3-AN4 differential channel becomes Analog Power (AN3xAN4) and Analog Energy (AN3xAN4xHours)</p>		

	<p>Apply voltage to AN1 and current to AN2.</p> <p>Apply voltage to AN3 and current to AN4.</p>		
<p>AN1_E_Channel_Ratio=1:1</p> <p>AN2_E_Channel_Ratio=1:1</p> <p>AN3_E_Channel_Ratio=1:1</p> <p>AN4_E_Channel_Ratio=1:1</p>	<p>You can use fractional values.</p>	<p>From 1:1 to 10000:1</p>	
<p>AN1_E_Range="HIGH"</p> <p>AN2_E_Range="HIGH"</p> <p>AN3_E_Range="HIGH"</p> <p>AN4_E_Range="HIGH"</p>	<p>Range for ANx_E input channels.</p> <p>HIGH range is (±100V Full scale)</p> <p>LOW range is (±10V Full scale)</p>	<p>HIGH</p> <p>LOW</p>	
<p>AN1_and_AN2_Measurement_Mode=DC</p> <p>AN3_and_AN4_Measurement_Mode=DC</p>	<p>If you are measuring an AC signal on the analog channels, set the measurement mode to AC to compute RMS (positive values only).</p> <p>If you are measuring a DC signal on the analog channels, set the measurement mode to DC to compute average (positive and negative values).</p>	<p>AC</p> <p>DC</p>	
<p>AN1_E_Channel_Name=AN1-E</p> <p>AN1_E_Channel_Unit=V</p> <p>AN2_E_Channel_Name=AN2-E</p> <p>AN2_E_Channel_Unit=A</p> <p>AN3_E_Channel_Name=AN3-E</p> <p>AN3_E_Channel_Unit=V</p> <p>AN4_E_Channel_Name=AN4-E</p> <p>AN4_E_Channel_Unit=A</p>	<p>Customize the names and units of your analog channels.</p>	<p>Valid names can be up to ? characters.</p> <p>Valid units are:</p> <p>"V", "A", "W", "DEG", "%", "NONE"</p>	
<p>[EnviroSensor_Probe_Setup]</p>			

<p>Probe_A_Serial_Number= Probe_A_Channel_Name= Probe_B_Serial_Number= Probe_B_Channel_Name=</p>	<p>If these tags are left blank, Probe_A is the first detected probe, Probe_B is the second detected probe.</p> <p>The environment Probe serial number format is "E" followed by 7 digits (e.g. "E3001163")</p>	<p>Serial Number: E300xxxx</p> <p>Valid names can be up to 7 characters.</p>	
--	---	--	--

6.1.2 Event Triggering

Setup.ini Tags	Comments	Valid Values	Example
[Phase_To_Neutral_Events]			
Phase_To_Neutral_Events=AUTO	Use the AUTO setting to let your PQube decide to record Phase-Neutral events. If your Power Configuration includes a Neutral conductor, your PQube will record Phase-Neutral events.	AUTO ON OFF	
Phase_To_Neutral_Dip_Threshold_In_Percent=90.00 Phase_To_Neutral_Swell_Threshold_In_Percent=110.00 Phase_To_Neutral_Interruption_Threshold_In_Percent=10.00 Phase_To_Neutral_Event_Hysteresis_In_Percent=2.00	Set thresholds for Voltage Dips, Swells, and Interruptions. Thresholds are expressed as percent remaining of nominal voltage.	For dips, any number between 0 and 100. For swells, any number greater than 100. For hysteresis, any number up to 100.	
[Phase_To_Phase_Events]			
Phase_To_Phase_Events=AUTO	Use the AUTO setting to let your PQube infer to record Phase-Phase events or not. If your Power Configuration includes multiple phases, your PQube will record Phase-Phase events.	AUTO ON OFF	
Phase_To_Phase_Dip_Threshold_In_Percent=90.00 Phase_To_Phase_Swell_Threshold_In_Percent=110.00 Phase_To_Phase_Interruption_Threshold_In_Percent=10.00 Phase_To_Phase_Event_Hysteresis_In_Percent=2.00	Set thresholds for Voltage Dips, Swells, and Interruptions. Percent refers to Percent remaining of nominal voltage.	For dips, any number between 0 and 100. For swells, any number greater than 100. For hysteresis, any number up to 100.	

[Phase_To_Neutral_RVC_Events]			
Phase_To_Neutral_RVC_Events=AUTO Phase_To_Neutral_RVC_Threshold_In_Percent=2.5 Phase_To_Neutral_RVC_Hysteresis_In_Percent=1.5		AUTO ON OFF	
[Phase_To_Phase_RVC_Events]			
Phase_To_Phase_RVC_Events=AUTO Phase_To_Phase_RVC_Threshold_In_Percent=6 Phase_To_Phase_RVC_Hysteresis_In_Percent=2		AUTO ON OFF	
[Snapshot_Events]			
Waveform_Snapshot_Interval_In_Hours=24	Trigger a waveform/RMS recording at scheduled time intervals.	OFF 3 6 24	
Enable_Snapshot_Harmonics=ON	Toggle Snapshot harmonic recordings	ON OFF	
Waveform_Snapshot_At_Startup=OFF	Set this tag to ON to take a Snapshot of your electric power every time your PQube is powered on or reset.	ON OFF	
Snapshot_Trigger_Hour=12	Define a specific time to trigger the Snapshot.	Any integer between 0 and 23	To record at 5:00pm everyday: Waveform_Snapshot_Interval_In_Hours=24 Snapshot_Trigger_Hour=17 To record every 3 hours starting at 8:00am: Waveform_Snapshot_Interval_In_Hours=3 Snapshot_Trigger_Hour=8

[AN1_E_Events]			
AN1_E_Events=OFF	<p>Set this tag to ON or OFF to toggle event triggering on your AN1-E channel.</p> <p>Set the value to USER_COUNTER to increment a counter every time an event occurs on this channel (no events, waveforms, or RMS envelopes will be generated). * USER_COUNTER not yet supported</p>	<p>ON</p> <p>OFF</p> <p>USER_COUNTER*</p>	
<p>AN1_E Dip_Threshold_In_Volts=2.00</p> <p>AN1_E Swell_Threshold_In_Volts=60.00</p> <p>AN1_E Event_Hysteresis_In_Volts=0.5</p>	<p>Set event detection thresholds for Analog channel 1.</p>	<p>Use the values after being transformed by the Analog ratios, not the actual voltage coming into the Analog terminals.</p>	
[AN2_E_Events]			
AN2_E_Events=OFF	<p>Set this tag to ON or OFF to toggle event triggering on your AN2-E channel.</p> <p>Set the value to USER_COUNTER to increment a counter every time an event occurs on this channel (no events, waveforms, or RMS envelopes will be generated). * USER_COUNTER not yet supported</p>	<p>ON</p> <p>OFF</p> <p>USER_COUNTER*</p>	
<p>AN2_E Dip_Threshold_In_Volts=2.00</p> <p>AN2_E Swell_Threshold_In_Volts=60.00</p> <p>AN2_E Event_Hysteresis_In_Volts=0.5</p>	<p>Set event detection thresholds for Analog channel 2.</p>	<p>Use the values after being transformed by the Analog ratios, not the actual voltage coming into the Analog terminals.</p>	
[AN1_AN2_Events]			
AN1_AN2_Events=OFF	<p>Set this tag to ON or OFF to toggle event triggering on your AN1-AN2 channel.</p> <p>Set the value to USER_COUNTER to increment a counter every time an event occurs on this channel (no events, waveforms, or RMS envelopes will be generated).</p>	<p>ON</p> <p>OFF</p> <p>USER_COUNTER*</p>	

	* USER_COUNTER not yet supported		
AN1_AN2_Dip_Threshold_In_Volts=2.00 AN1_AN2_Swell_Threshold_In_Volts=60.00 AN1_AN2_Event_Hysteresis_In_Volts=0.5	Set event detection thresholds for AN1-AN2 voltage.	Use the values after being transformed by the Analog ratios, not the actual voltage coming into the Analog terminals.	
[AN3_E_Events]			
AN3_E_Events=OFF	Set this tag to ON or OFF to toggle event triggering on your AN3-E channel. Set the value to USER_COUNTER to increment a counter every time an event occurs on this channel (no events, waveforms, or RMS envelopes will be generated). * USER_COUNTER not yet supported	ON OFF USER_COUNTER*	
AN3_E_Dip_Threshold_In_Volts=2.00 AN3_E_Swell_Threshold_In_Volts=60.00 AN3_E_Event_Hysteresis_In_Volts=0.5	Set event detection thresholds for Analog channel 3.	Use the values after being transformed by the Analog ratios, not the actual voltage coming into the Analog terminals.	
[AN4_E_Events]			
AN4_E_Events=OFF	Set this tag to ON or OFF to toggle event triggering on your AN3-E channel. Set the value to USER_COUNTER to increment a counter every time an event occurs on this channel (no events, waveforms, or RMS envelopes will be generated). * USER_COUNTER not yet supported	ON OFF USER_COUNTER*	
AN4_E_Dip_Threshold_In_Volts=2.00 AN4_E_Swell_Threshold_In_Volts=60.00 AN4_E_Event_Hysteresis_In_Volts=0.5	Set event detection thresholds for Analog channel 4.	Use the values after being transformed by the Analog ratios, not the actual voltage coming into the Analog terminals.	
[AN3_AN4_Events]			
AN3_AN4_Events=OFF	Set this tag to ON or OFF to toggle event triggering	ON	

	<p>on your AN3-AN4 channel.</p> <p>Set the value to USER_COUNTER to increment a counter every time an event occurs on this channel (no events, waveforms, or RMS envelopes will be generated).</p> <p>* USER_COUNTER not yet supported</p>	<p>OFF</p> <p>USER_COUNTER*</p>	
<p>AN3_AN4_Dip_Threshold_In_Volts=2.00</p> <p>AN3_AN4_Swell_Threshold_In_Volts=60.00</p> <p>AN3_AN4_Event_Hysteresis_In_Volts=0.5</p>	<p>Set event detection thresholds for AN3-AN4 voltage.</p>	<p>Use the values after being transformed by the Analog ratios, not the actual voltage coming into the Analog terminals.</p>	
[Frequency_Events]			
Frequency_Events=ON	<p>Toggle events for underfrequency and overfrequency.</p>	<p>ON</p> <p>OFF</p>	
<p>Underfrequency_Threshold_In_Percent=99.50</p> <p>Overfrequency_Threshold_In_Percent=100.50</p> <p>Frequency_Event_Hysteresis_In_Percent=0.20</p>	<p>Set thresholds for frequency event detection here.</p>	<p>For underfrequency events, any value between 0 and 100.</p> <p>For overfrequency events, any value above 100.</p> <p>For hysteresis, any value between 0 and 100.</p>	
[Phase_Current_Events]			
Phase_Current_Events=OFF	<p>Trigger events for current on L1, L2, and/or L3.</p>	<p>ON</p> <p>OFF</p>	
<p>Phase_Current_Level_Threshold_In_Amps= AUTO</p> <p>Phase_Current_Level_Hysteresis_In_Amps= AUTO</p>	<p>Set the level threshold here. Your PQube will record an event when the current crosses above this level.</p> <p>AUTO sets the threshold to your full-scale current. To determine your full-scale current, multiply your CT ratio by the full-scale input rating of your current inputs (0.333V for LOW range, ±10Vpk for high range).</p>	<p>AUTO</p> <p>Any positive number (in amps).</p>	

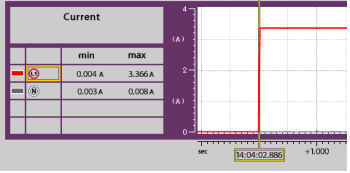
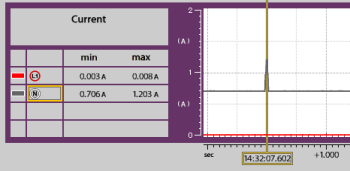
	<p>Example: CT ratio = 100A:0.333V Full-scale of current input=0.333V $100:0.333 * 0.333 = 100A$</p> <p>AUTO for hysteresis defaults to 4% of threshold.</p>		
<p>Phase_Current_Inrush_Threshold_In_Amps= AUTO</p> <p>Phase_Current_Inrush_Threshold_In_Cycles= 2</p>	<p>Set the inrush threshold here. Your PQube will record an event when the increase of current exceeds the Inrush_Threshold_In_Amps value, within a period of the Inrush_Threshold_In_Cycles or less.</p> <p>AUTO sets the threshold to your full-scale current. To determine your full-scale current, multiply your CT ratio by the full-scale input rating of your current inputs (0.333V for LOW range, ±10Vpk for high range).</p> <p>Example: CT ratio = 100A:0.333V Full-scale of current input=0.333V $100:0.333 * 0.333 = 100A$</p>	<p>AUTO</p> <p>Any value greater than 0 for inrush threshold in amps.</p> <p>Any integer value greater than 0 for inrush threshold in cycles.</p>	
[Neutral_Current_Events]			
Neutral_Current_Events=OFF	Trigger events for current on the Neutral channel.	<p>ON</p> <p>OFF</p>	
<p>Neutral_Current_Level_Threshold_In_Amps= AUTO</p> <p>Neutral_Current_Level_Hysteresis_In_Amps =AUTO</p>	<p>Set the level threshold here. Your PQube will record an event when the current crosses above this level.</p> <p>AUTO sets the threshold to your full-scale current. To determine your full-scale current, multiply your CT ratio by the full-scale input rating of your current inputs (0.333V for LOW range, ±10Vpk for high range).</p> <p>Example:</p>	<p>AUTO</p> <p>Any positive number in amps.</p>	

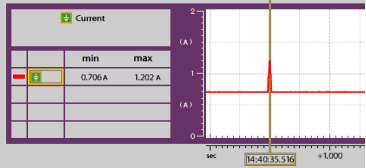
	<p>CT ratio = 100A:0.333V Full-scale of current input=0.333V $100:0.333 * 0.333 = 100A$</p> <p>AUTO for hysteresis defaults to 4% of threshold.</p>		
<p>Neutral_Current_Inrush_Threshold_In_Amps =AUTO</p> <p>Neutral_Current_Inrush_Threshold_In_Cycles =2</p>	<p>Set the inrush threshold here. Your PQube will record an event when the increase of current exceeds the Inrush_Threshold_In_Amps value, within a period of the Inrush_Threshold_In_Cycles or less.</p> <p>AUTO sets the threshold to your full-scale current. To determine your full-scale current, multiply your CT ratio by the full-scale input rating of your current inputs (0.333V for LOW range, ±10Vpk for high range).</p> <p>Example: CT ratio = 100A:0.333V Full-scale of current input=0.333V $100:0.333 * 0.333 = 100A$</p>	<p>AUTO</p> <p>Any value greater than 0 for inrush threshold in amps.</p> <p>Any integer value greater than 0 for inrush threshold in cycles.</p>	
[Earth_Current_Events]			
Earth_Current_Events=OFF	Trigger Earth Current events.	<p>ON</p> <p>OFF</p>	
<p>Earth_Current_Level_Threshold_In_Amps= AUTO</p> <p>Earth_Current_Level_Hysteresis_In_Amps= AUTO</p>	<p>Set the level threshold here. Your PQube will record an event when the current crosses above this level.</p> <p>AUTO sets the threshold to your full-scale current. To determine your full-scale current, multiply your CT ratio by the full-scale input rating of your current inputs (0.333V for LOW range, ±10Vpk for high range).</p> <p>Example: CT ratio = 100A:0.333V Full-scale of current input=0.333V</p>	<p>AUTO</p> <p>Any positive number in amps.</p>	

	<p>$100:0.333 * 0.333 = 100A$</p> <p>AUTO for hysteresis defaults to 4% of threshold.</p>		
<p>Earth_Current_Inrush_Threshold_In_Amps= AUTO</p> <p>Earth_Current_Inrush_Threshold_In_Cycles= 2</p>	<p>Set the inrush threshold here. Your PQube will record an event when the increase of current exceeds the Inrush_Threshold_In_Amps value, within a period of the Inrush_Threshold_In_Cycles or less.</p> <p>AUTO sets the threshold to your full-scale current. To determine your full-scale current, multiply your CT ratio by the full-scale input rating of your current inputs (0.333V for LOW range, ±10Vpk for high range).</p> <p>Example: CT ratio = 100A:0.333V Full-scale of current input=0.333V $100:0.333 * 0.333 = 100A$</p>	<p>AUTO</p> <p>Any value greater than 0 for inrush threshold in amps.</p> <p>Any integer value greater than 0 for inrush threshold in cycles.</p>	
[Major_Dip_Events]			
Major_Dip_Threshold_Settings=OFF	<p>Major Dips are defined by the selected depth/duration curve. This is useful for emulating PSL's PQ1 Power Quality Relay.</p> <p>When a dip exceeds the thresholds as specified by the selected standard, it will be characterized as a Major Dip.</p>		
<p>Major_Dip_Threshold_Level_1_in_Percent=OFF</p> <p>Major_Dip_Threshold_Level_1_Duration_in_Seconds=0</p> <p>Major_Dip_Threshold_Level_2_in_Percent=OFF</p> <p>Major_Dip_Threshold_Level_2_Duration_in_Seconds=0</p> <p>Major_Dip_Threshold_Level_3_in_Percent=OFF</p> <p>Major_Dip_Threshold_Level_3_Duration_in_Seconds=0</p> <p>Major_Dip_Threshold_Level_4_in_Percent=OFF</p>	<p>This configuration is only valid if you set the Major_Dip_Threshold_Setting to CUSTOM for the user to create their own custom threshold. Each additional threshold has to be lower than the previous, and each duration has to be shorter.</p> <p>Example of valid Usage:</p> <p>Major_Dip_Threshold_Level_1_in_Percent=80</p> <p>Major_Dip_Threshold_Level_1_Duration_in_Seconds=5</p> <p>Major_Dip_Threshold_Level_2_in_Percent=50</p>		

Major_Dip_Threshold_Level_4_Duration_in_Seconds=0	Major_Dip_Threshold_Level_2_Duration_in_Seconds=0.5 Example of invalid Usage: Major_Dip_Threshold_Level_1_in_Percent=70 Major_Dip_Threshold_Level_1_Duration_in_Seconds=2 Major_Dip_Threshold_Level_2_in_Percent=80 Major_Dip_Threshold_Level_2_Duration_in_Seconds=1		
[Waveshape_Change_Events]			
Waveshape_Change_Events=ON	Trigger a Waveshape Change when the voltage waveform changes abruptly. This is useful for detecting power factor correction capacitor switching.	ON OFF	
Voltage_Threshold_In_Percent_Of_Nominal=20.00 Duration_Threshold_In_Percent_Of_Cycle=10.00	Uses the “Floating Window” algorithm. Each Nth sample of the present cycle defines the threshold for the Nth sample of the next cycle. If the voltage change from one cycle to the next exceeds the selected threshold, for the selected duration or longer, a Waveshape Change will be triggered.	For voltage threshold, any number up to 100. For duration threshold, any number to 100.	
[DIG1_Events]			
Enable_DIG1_Low_Event=OFF Enable_DIG1_High_Event=OFF	Trigger events on the DIG1 channel. WARNING: Do not enable both DIG1_Low and DIG1_High events at the same time. It will result in an infinitely long event which will prevent your PQube from recording waveform and RMS graphs for other events.	ON OFF	
DIG1_Low_Threshold=0.2 DIG1_Event_Hysteresis=0.1 DIG1_High_Threshold=0.7		Any number between 0 and 1.	
[EnviroSensor_Probe_Events]			
Probe_A_Overtemperature_Events=OFF	Define upper/lower thresholds and hysteresis for	ON	

<p>Probe_A_Undertemperature_Events=OFF</p> <p>Probe_A_Undertemperature_Threshold_in_Deg_C=0</p> <p>Probe_A_Overtemperature_Threshold_in_Deg_C=50</p> <p>Probe_A_Temperature_Event_Hysteresis_in_Deg_C=2</p> <p>Probe_A_High_Humidity_Events=OFF</p> <p>Probe_A_Low_Humidity_Events=OFF</p> <p>Probe_A_Low_Humidity_Threshold_in_Percent_RH=5</p> <p>Probe_A_High_Humidity_Threshold_in_Percent_RH=90</p> <p>Probe_A_Humidity_Event_Hysteresis_in_Percent_RH=2</p> <p>Probe_B_Overtemperature_Events=OFF</p> <p>Probe_B_Undertemperature_Events=OFF</p> <p>Probe_B_Undertemperature_Threshold_in_Deg_C=0</p> <p>Probe_B_Overtemperature_Threshold_in_Deg_C=50</p> <p>Probe_B_Temperature_Event_Hysteresis_in_Deg_C=2</p> <p>Probe_B_High_Humidity_Events=OFF</p> <p>Probe_B_Low_Humidity_Events=OFF</p> <p>Probe_B_Low_Humidity_Threshold_in_Percent_RH=5</p> <p>Probe_B_High_Humidity_Threshold_in_Percent_RH=95</p> <p>Probe_B_Humidity_Event_Hysteresis_in_Percent_RH=2</p>	<p>temperature and humidity here.</p>	<p>OFF</p> <p>For temperature events, any number in degrees C.</p> <p>For humidity events, any number in %RH.</p>	
--	---------------------------------------	---	--

[HF_Impulse_Events]			
HF_Impulse_Recording=OFF	Toggle high-frequency impulse detection and recording.	ON OFF	
HF_Impulse_Configuration=4-channels	Record HF impulses on one channel (L1-E) at 4MHz sampling rate, or on 4 channels at 1MHz sampling rate per channel.	L1-E 4-channels	
HF_Impulse_Threshold_in_Volts=2000	Threshold for positive and negative HF impulse events in Volts	Range between 200 x the PT ratio and 5000 x the PT ratio	
[Mains_Signaling]			
Mains_Signaling_Events=OFF Mains_Signaling_Threshold_In_Volts=60 Mains_Signaling_Recording_Period_In_Seconds=60	Set up Mains Signaling events (also called ripple control) according to the requirements of IEC 61000-4-30 Class A Section 5.10. Define the threshold and recording period here.		
Mains_Signaling_Channel=L1	Set which channel your PQube 3 monitors the Mains Signaling frequency on.	L1 L2 L3	
Mains_Signaling_Harmonic_In_Hz=	Specify the Mains Signaling frequency of interest.		

6.1.3 Network Configuration

Setup.ini Tags	Comments	Valid Values	Example
[Network_Setup]			
IP_Address_Method=Use_DHCP	If you are automatically assigned an IP address by your network, use DHCP. If you are using a static IP, use Fixed IP.	Use_DHCP Use_Fixed_IP	
[Fixed_IP]			
IP_Address=	Enter your IP address information here. This		

IP_Mask= IP_Gateway= IP_DNS1= IP_DNS2=	information is ignored if DHCP is selected.		
[Email_Server_Settings]	Set up the email account for your PQube 3 here. IMPORTANT: Your PQube needs its own e-mail account. Do not assign your personal email account to your PQube – PSL is not liable for any loss of data. All PQubes come with a free, temporary PQube.com e-mail account from PSL. Contact support@powerstandards.com for more information.		
POP_Email_Server_Address= POP_Email_Server_Port= Incoming_Email_Protocol=	Incoming email server settings. Ask your IT administrator for this information.		POP_Email_Server_Address=[mail.pqube.com] POP_Email_Server_Port=110 Incoming_Email_Protocol=POP
Incoming_Email_SSL_Encryption=OFF	Toggle SSL/TLS encryption while retrieving email commands	ON OFF	
SMTP_Server_Address= SMTP_Server_Port=	Outgoing email server settings. Ask your IT administrator for this information.		SMTP_Server_Address=[mail.pqube.com] SMTP_Server_Port=25
Outgoing_Email_SSL_Encryption=OFF	Toggle SSL/TLS encryption while sending emails	ON OFF	
PQube_Email_Account= PQube_Email_Password=	IMPORTANT: Your PQube needs its own e-mail account. Do NOT assign your personal e-mail account to your PQube. Your PQube automatically clears out the inbox after processing email commands.		PQube_Email_Account=p3001234@pqube.com PQube_Email_Password=p3001234
Email_Address_Provider=PSL	Use pre-programmed email server settings. The server settings above do not need to be specified if using PSL, GMAIL, or NTT.	PSL GMAIL	

		NTT OTHER	
[Email_Commands_To_PQube3]	<p>You can send commands to your PQube using the email subject line. Your PQube checks its inbox for new incoming emails and processes each command one at a time.</p> <p>Refer to page 61 for a list of available email commands.</p>		
Email_Commands=OFF	Toggle email commands (incoming emails to your PQube 3)	ON OFF	
Check_Every_N_Seconds=300	<p>How often your PQube 3 checks its inbox for new email commands.</p> <p>IMPORTANT: For PQube 3, this interval is in seconds, not minutes (like the original PQube).</p>		
Subject_Must_Begin_With=PQube3	Your PQube will only accept incoming emails when the Subject begins with this keyword. Use this as an added layer of security.		<p>Subject_Must_Begin_With=PQube3</p> <p>Email Subject: PQube3 Firmware Update</p>
<p>Email_Must_Be_From_1=</p> <p>Email_Must_Be_From_2=</p> <p>Email_Must_Be_From_3=</p> <p>Email_Must_Be_From_4=</p> <p>Email_Must_Be_From_5=</p>	<p>Your PQube 3 only accepts email commands from the email addresses in this list.</p> <p>If no email addresses are specified, your PQube 3 will accept email commands from anyone.</p>		
<p>Ignore_Sender_Containing_1=</p> <p>Ignore_Sender_Containing_2=</p> <p>Ignore_Sender_Containing_3=</p> <p>Ignore_Sender_Containing_4=</p> <p>Ignore_Sender_Containing_5=</p>	<p>Your PQube 3 ignores emails from email addresses that contain the following keywords, and are not on the Email_Must_Be_From list.</p> <p>Ignored emails do not trigger notifications to be sent to the email postmaster.</p> <p>Valid keywords are 2 to x characters.</p>		
[Email_Notifications_From_PQube3]	Your PQube can send you an email whenever it generates an event, snapshot, trend, or if it resets.		

<p>Enable_Event_Summary_Email=OFF</p>	<p>Summary emails are short, plain-text event notifications. These are typically sent to a manager who does not need the specific details of an event.</p>	<p>ON OFF</p>	
<p>Send_Reset_Emails=ON Send_Events_Emails=ON Send_Trends_Emails=ON Send_Snapshot_Emails=ON</p>	<p>Choose which types of emails you want from your PQube. Useful for reducing your data usage by receiving only the types of emails that you need.</p>	<p>ON OFF</p>	
<p>Email_Body_Type=Human_Readable_HTML</p>	<p>Set the format of the email body. Use HTML for easy viewing of the email. Use text to read the email without an HTML interpreter. Use XML if you want a program to process the emails.</p>	<p>Human_Readable_HTML Human_Readable_Text Machine_Readable_XML</p>	
<p>; ----- Distribution list of summary emails Event_Summary_Email_To_1= Event_Summary_Email_To_2= Event_Summary_Email_To_3= ; ----- CC distribution list of summary emails Event_Summary_Email_CC_1= Event_Summary_Email_CC_2= Event_Summary_Email_CC_3= ; ----- BCC distribution list of summary emails Event_Summary_Email_BCC_1= Event_Summary_Email_BCC_2= Event_Summary_Email_BCC_3=</p>	<p>Set the To, CC, and BCC recipients of the summary emails.</p>		
<p>; ----- Distribution list of emails</p>	<p>Set the To, CC, and BCC recipients of the standard PQube emails which contain detailed email bodies</p>		

<p>Email_To_1= Email_To_2= Email_To_3= Email_To_4= Email_To_5= ; ----- CC Distribution list of emails Email_CC_1= Email_CC_2= Email_CC_3= Email_CC_4= Email_CC_5= ; ----- BCC Distribution list of emails Email_BCC_1= Email_BCC_2= Email_BCC_3= Email_BCC_4= Email_BCC_5=</p>	<p>and attachments.</p>		
<p>Email_Errors_To=</p>	<p>The recipient in the Errors_To field will receive a notification whenever an email command was sent unsuccessfully, with the reason for failure (wrong subject keyword, email not on whitelist, etc.).</p>		

6.1.4 Protocols and Synchronization

[Modbus]			
Modbus_Slave_Device_Address=1	Set according to the Modbus SCADA/master application		
Modbus_TCP_port=502	Set according to the Modbus SCADA/master application		
Modbus_Register_Start_Address=7000			
Byte_Order=BIG_ENDIAN	Big Endian byte order stores the most significant number in the first byte. Little Endian byte order stores the least significant number in the first byte.	BIG_ENDIAN LITTLE_ENDIAN	
[Output_Formatting]			
Decimal_Separator="."" Date_Separator="/" " Time_Separator=":" " CSV_Separator="," "	Set the Decimal, Date, Time, and CSV separator characters here. These affect the PQube display, the meters on the web interface, emails, and output files. NOTE: You must still use a decimal point as the decimal separator for all numbers that you enter in the Setup.ini file.		
[SNMP_Settings]			
SNMPD_Polling=OFF	Toggle SNMP polling.	ON OFF	
SNMPD_Traps=OFF	Toggle SNMP traps.	ON OFF	
SNMP_Trap_Server= SNMP_Port=161	Set the IP address and port of your SNMP trap server.	Valid IPv4 address and port number	
SNMP_Trap_Version=v3	Choose SNMP v2c or v3 and define SNMP settings.	v2c v3	

SNMP_V1_V2_Community_Name=public	Parameter specific to TRAP v2		
SNMP_V3_Security_Level=AuthPriv	Set the security level for TRAP v3	noAuthNoPriv authNoPriv authPriv	
SNMP_V3_User_Name=MD5DESUser SNMP_V3_Auth_Protocol=MD5 SNMP_V3_Auth_Password=MD5UserPassword SNMP_V3_Priv_Protocol=DES SNMP_V3_Priv_Password=DESUserPassword	Parameters specific to TRAP v3		
[SNTP_Settings]	Your PQube can synchronize its clock to UTC using Simple Network Time Protocol (SNTP).		
Enable_SNTP=OFF	Synchronize your PQube's time clock using SNTP	ON OFF	
SNTP_Server=pool.ntp.org	Set the SNTP server address.		
SNTP_Update_Interval_In_Hours=24	Define how often your PQube 3 synchronizes with the SNTP server.	1 to 168	
[NTP_Settings]	Your PQube can synchronize its clock to UTC using Network Time Protocol (NTP). NTP is more accurate than SNTP.		
Enable_NTP=OFF	Toggle NTP synchronization.	ON OFF	
NTP_Server=north-america.pool.ntp.org	Set the NTP server address.		
NTP_Update_Interval_In_Hours=1	Define how often your PQube 3 synchronizes with the NTP server.	1 to 168	

6.1.5 System and Services

[HTTP_Web_Server_Settings]			
HTTP_Web_Server_Commands_Page=ON	Toggle the Commands page on the web server.	ON OFF	
HTTP_Web_Server_Port=80	HTTP port used to access the PQube3 web server pages - default is 80		
HTTP_Web_Server_Command_Port=8888	HTTP port used to access the PQube3 web server Commands page - default is 8888		
Require_HTTP_Authorization=OFF HTTP_User_Name= HTTP_Password=	Restrict general access to your PQube's Web Server (default tag OFF), you will be prompted with user and password to access the web pages		
Require_HTTP_Admin_Authorization=OFF HTTP_Admin_User_Name=admin HTTP_Admin_Password=admin	Restrict access to the Commands section of your PQube's Web Server (tag default OFF) , you will be prompted with user and password to access the web pages		
[FTP Settings]	Manage the built-in FTP server in your PQube 3.		
FTP_Password_1= FTP_Password_2= FTP_Password_3= FTP_Password_4= FTP_Password_5=	<p>You can manage up to 5 FTP users: Those users are:</p> <p>ftp_user_1 ftp_user_2 ftp_user_3</p> <p>ftp_config – for retrieving or sending the setup file. This user uses FTP_Password_4.</p> <p>ftp_updater – for firmware update via FTP</p> <p>The user names are fixed and cannot be changed.</p> <p>If no password is assigned for a profile, that user does not have access.</p> <p>Password must be at least 8 characters.</p>		

6.1.6 Trend Setup

Setup.ini Tags	Comments	Valid Values	Example
[Trend_Settings]			
Enable_Daily_Trends=ON Enable_Weekly_Trends=ON Enable_Monthly_Trends=ON	Daily Trends and Statistics are recorded every midnight. Weekly Trends and Statistics are recorded every midnight between Sunday and Monday using ISO 8601 methods. Monthly Trends and Statistics are recorded every midnight after the last day of the month.	ON OFF	
Trend_Individual_Phases=ON	If OFF, your PQube records worst-case and average of all phases. If ON, your PQube also records the values of individual phases. This data is available for Voltage, Current, and Power.	ON OFF	
Omit_IEC_Flagged_Data_From_Stats=ON	Disturbances on your power line can skew your statistics, so you can omit these values from the statistics.	ON OFF	
Power_Polarity_of_Interest=POSITIVE	Set to Positive for power consumption, set to negative for power generation, or set to BOTH if you are monitoring consumption and generation.	POSITIVE NEGATIVE BOTH	
Min_Volts_of_Interest_in_Percent_of_Nominal=AUTO* Max_Volts_of_Interest_in_Percent_of_Nominal=AUTO*	Set the minimum and maximum voltage for viewing in Trends and Statistics recordings if the AUTO setting does not provide a suitable graph. The AUTO setting is determined by the Voltage Dip and Swell thresholds. Your PQube intentionally does not auto-scale the Trends and Statistics graphs. This makes it easy to visually compare trends recorded at different times. *AUTO not yet available for this tag	AUTO Any number [percent]	
Min_Current_of_Interest_in_Amps=AUTO*	Set the minimum and maximum current for viewing in Trends and Statistics recordings if the AUTO setting	AUTO Any number	

<p>Max_Current_of_Interest_in_Amps=AUTO*</p>	<p>does not provide a suitable graph.</p> <p>The AUTO setting is determined by your full-scale current.</p> <p>*AUTO not yet available for this tag</p>	<p>[amps]</p>	
<p>Min_Neutral_Current_of_Interest_in_Amps=AUTO*</p> <p>Max_Neutral_Current_of_Interest_in_Amps=AUTO*</p>	<p>If your PQube is calculating the Earth Current, AUTO sets the Max_Earth_Current_of_Interest_in_Amps to 5% of the Max_Current_of_Interest_in_Amps value.</p> <p>If measuring the Earth Current with a current transformer, the AUTO setting is determined by your CT ratio and the nominal current rating of your current sensing module.</p> <p>*AUTO not yet available for this tag</p>	<p>AUTO</p> <p>Any number [amps]</p>	
<p>Min_Earth_Current_of_Interest_in_Amps=AUTO*</p> <p>Max_Earth_Current_of_Interest_in_Amps=AUTO*</p>	<p>If your PQube is calculating the Earth Current, AUTO sets the Max_Earth_Current_of_Interest_in_Amps to 5% of the Max_Current_of_Interest_in_Amps value.</p> <p>If measuring the Earth Current with a current transformer, the AUTO setting is determined by your CT ratio and the nominal current rating of your current sensing module.</p> <p>*AUTO not yet available for this tag</p>	<p>AUTO</p> <p>Any number [amps]</p>	
<p>Min_Frequency_of_Interest_in_Percent_of_Nominal=AUTO*</p> <p>Max_Frequency_of_Interest_in_Percent_of_Nominal=AUTO*</p>	<p>The AUTO values are determined by the Underfrequency and Overfrequency thresholds.</p> <p>*AUTO not yet available for this tag</p>	<p>AUTO</p> <p>Any number [Hz]</p>	
<p>Min_AN1_E_of_Interest_in_RMS_volts=AUTO*</p> <p>Max_AN1_E_of_Interest_in_RMS_volts=AUTO*</p>	<p>The AUTO values are determined by the Dip and Swell thresholds on Analog Channel 1.</p> <p>*AUTO not yet available for this tag</p>	<p>AUTO</p> <p>Any number [volts]</p>	
<p>Min_AN2_E_of_Interest_in_RMS_volts=AUTO*</p> <p>Max_AN2_E_of_Interest_in_RMS_volts=AUTO*</p>	<p>The AUTO values are determined by the Dip and Swell thresholds on Analog Channel 2.</p> <p>*AUTO not yet available for this tag</p>	<p>AUTO</p> <p>Any number [volts]</p>	
<p>Min_AN1_AN2_of_Interest_in_RMS_volts=AUTO*</p>	<p>The AUTO values are determined by the AN1-AN2 Dip and Swell thresholds.</p>	<p>AUTO</p>	

Max_AN1_AN2_of_Interest_in_RMS_volts=AUTO*	*AUTO not yet available for this tag	Any number [volts]	
Min_AN3_E_of_Interest_in_RMS_volts=AUTO* Max_AN3_E_of_Interest_in_RMS_volts=AUTO*	The AUTO values are determined by the Dip and Swell thresholds on Analog Channel 3. *AUTO not yet available for this tag	AUTO Any number [volts]	
Min_AN4_E_of_Interest_in_RMS_volts=AUTO* Max_AN4_E_of_Interest_in_RMS_volts=AUTO*	The AUTO values are determined by the Dip and Swell thresholds on Analog Channel 4. *AUTO not yet available for this tag	AUTO Any number [volts]	
Min_AN3_AN4_of_Interest_in_RMS_volts=AUTO* Max_AN3_AN4_of_Interest_in_RMS_volts=AUTO*	The AUTO values are determined by the AN3-AN4 Dip and Swell thresholds. *AUTO not yet available for this tag	AUTO Any number [volts]	
Min_Temperature_of_Interest_in_DegC=0 Max_Temperature_of_Interest_in_DegC=50	Set the minimum and maximum temperature for viewing in Trends and Statistics recordings if the AUTO setting does not provide a suitable graph.	Any number [degrees °C]	
Min_Humidity_of_Interest_in_%_RH=0 Max_Humidity_of_Interest_in_%_RH=100	Set the minimum and maximum relative humidity in % for viewing in Trends and Statistics recordings.	Any number [%RH]	
Max_Voltage_Unbalance_of_Interest_in_Percent=10 %	Set the full scale Voltage Unbalance in Trends and Statistics recordings.	Any number [%]	
Max_Current_Unbalance_of_Interest_in_Percent=99 %	Set the full scale Current Unbalance in Trends and Statistics recordings.	Any number [%]	
Max_Voltage_THD_of_Interest_in_Percent=10%	Set the full scale THD voltage in Trends and Statistics recordings.	Any number [%]	
Max_Current_TDD_of_Interest_in_Percent=25%*	Set the full scale TDD current in Trends and Statistics recordings.	Any number [%]	
Max_Flicker_of_Interest=4	Set the full scale RMS Flicker in Trends and Statistics recordings.	Any number	

7 Appendix 2: Major Dip Curves

Your PQube supports the following world-wide standards: STANDARD (IEC 61000-4-34), SEMI F47, Samsung Power Vaccine, ITIC, CBEMA, MIL-STD 704E, and MIL-STD 1399. These standards define ride-through curves based on the depth and duration of voltage dips. When the voltage dips below the ride-through curve, your PQube will trigger a Major Dip event. You can specify which standard to use in your **Setup.ini** file.

This is especially useful for electrical systems manufacturers, who must design their equipment to withstand voltage sags that do not dip below the ride-through curve.

7.1.1 STANDARD

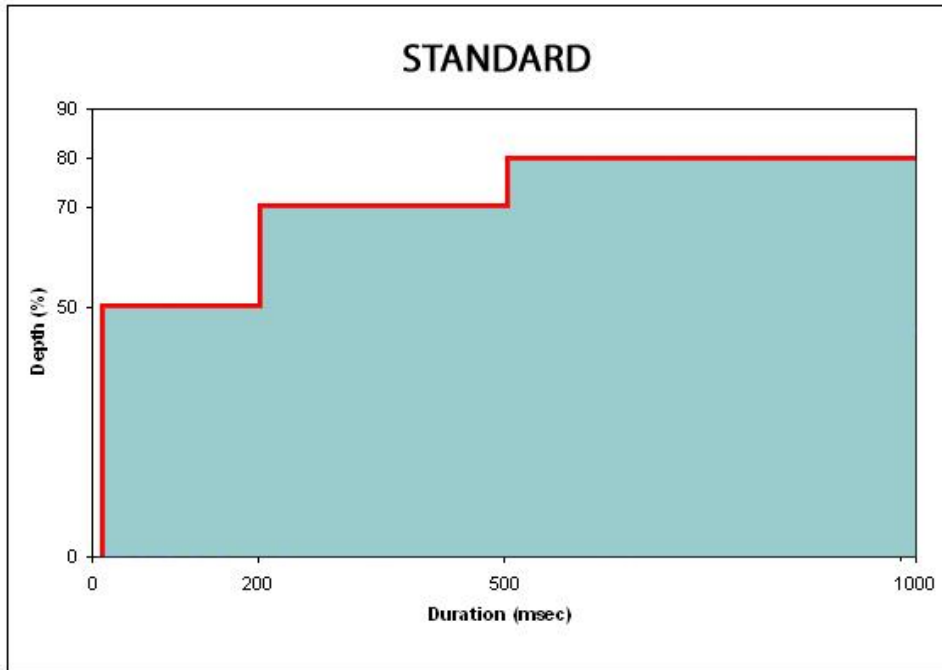

NOTE: Use this curve to detect only events that lie outside the SEMI F47 boundary.

7.1.2 SEMI F47

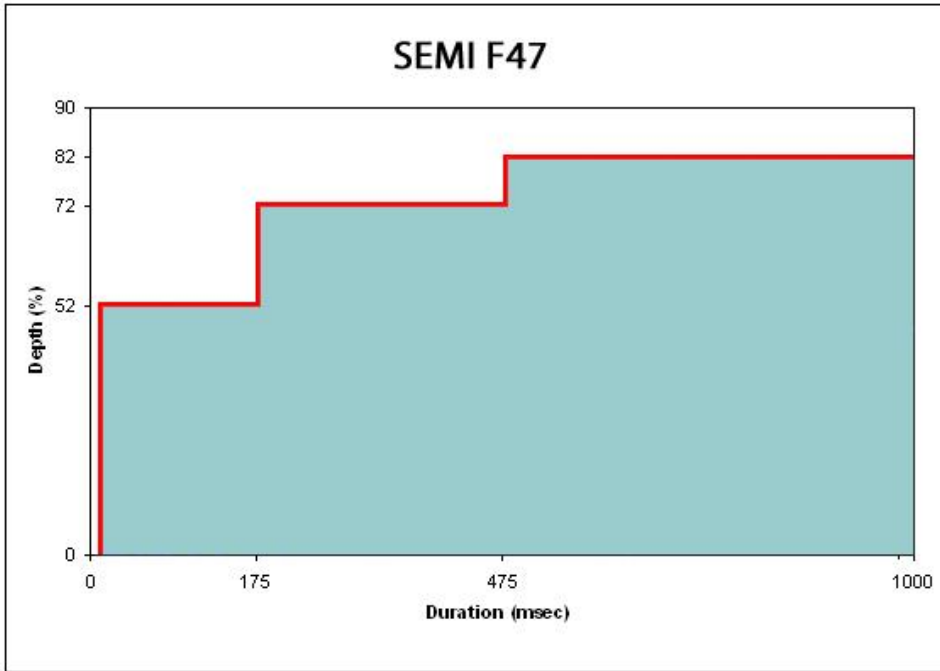

NOTE: Use this curve to guarantee that a Major Dip is detected for events that lie directly on the SEMI F47 boundary.

7.1.3 Samsung Power Vaccine

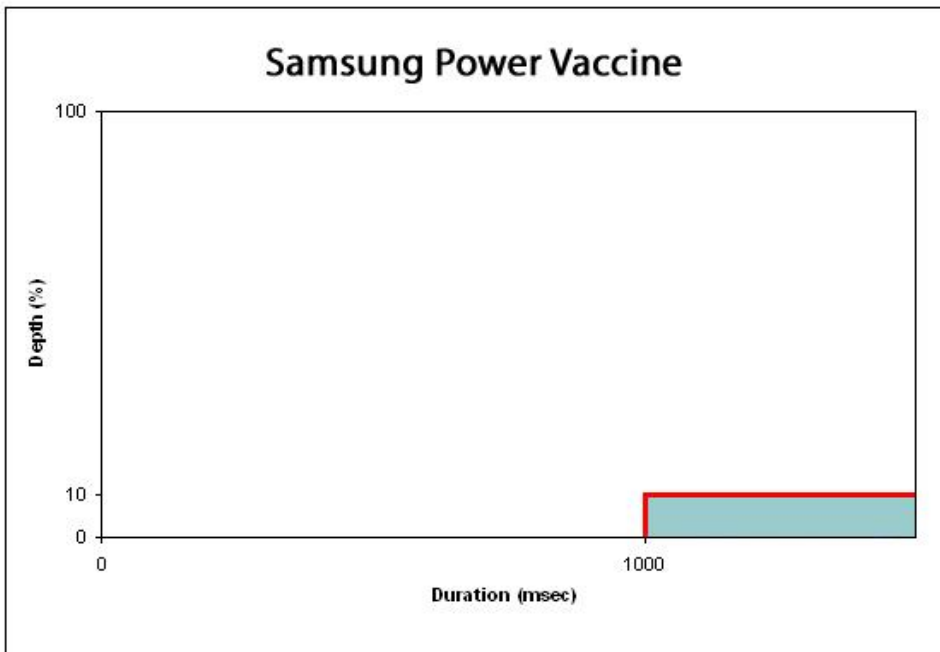

7.1.4 ITIC

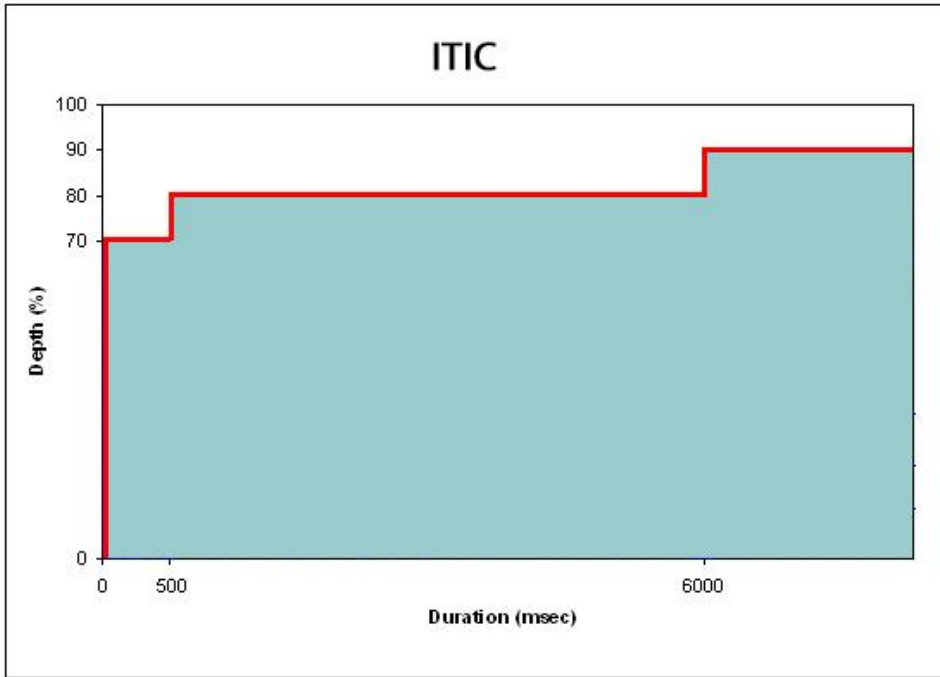

7.1.5 CBEMA

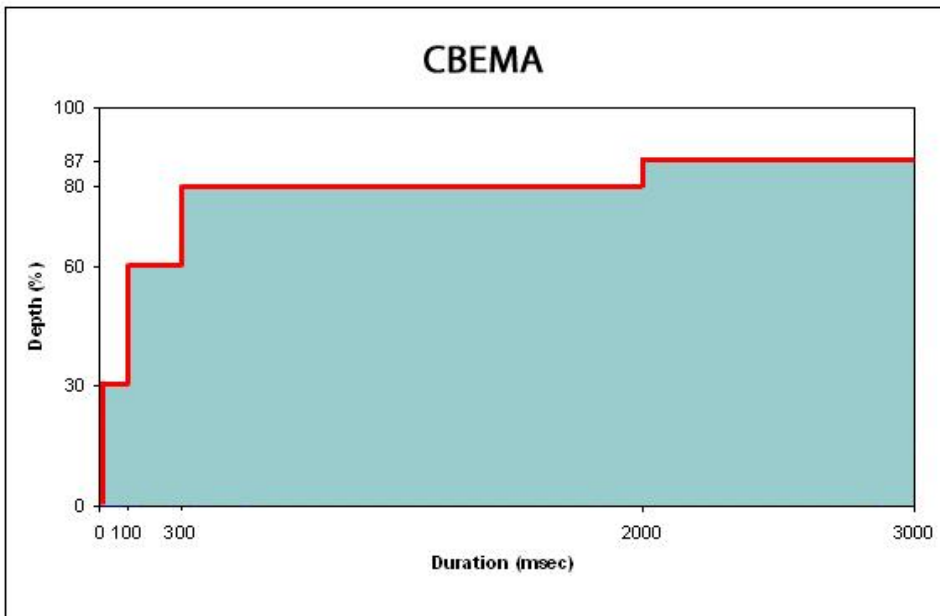

7.1.6 MIL-STD 704E

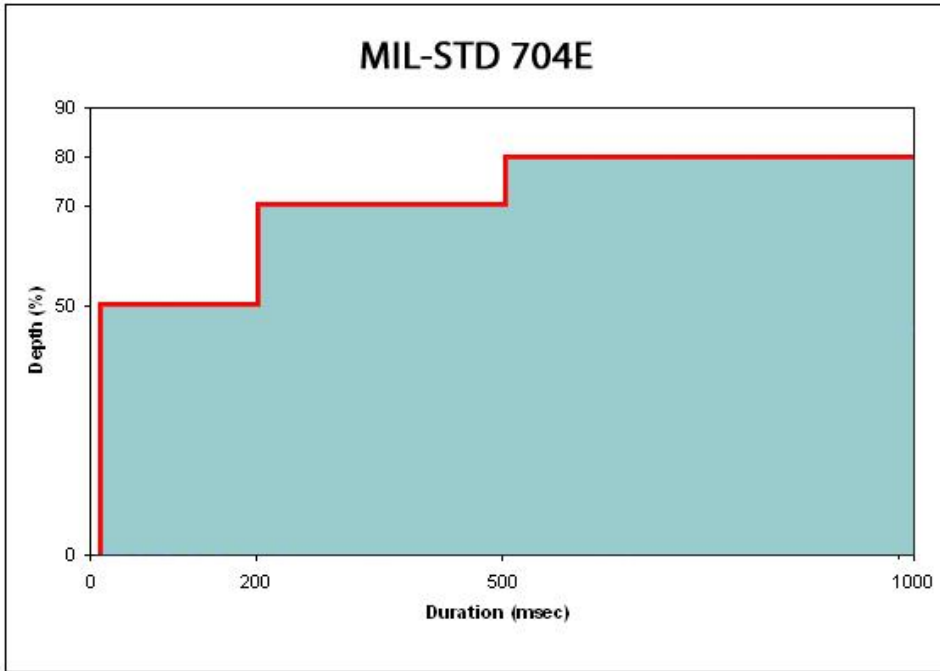

7.1.7 MIL-STD 1399

